

Installation Instructions

Vehicle Detection Sensor for Gate

Virtual Loop

Surface mount OVS-02GT

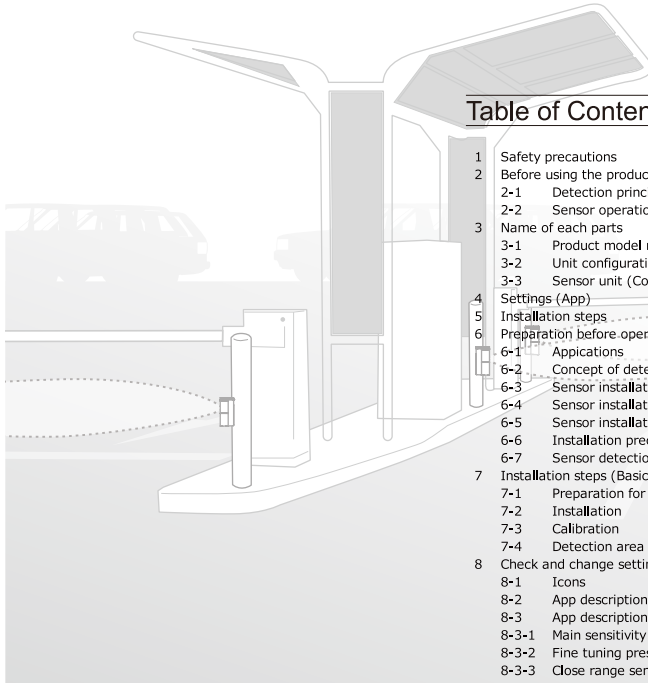

Table of Contents

1	Safety precautions	P.2
2	Before using the product	
2-1	Detection principle of the sensor	P.3
2-2	Sensor operation	P.3
3	Name of each parts	
3-1	Product model number	P.4
3-2	Unit configuration	P.4
3-3	Sensor unit (Common for all models)	P.5
4	Settings (App)	P.6
5	Installation steps	P.7
6	Preparation before operation	
6-1	Applications	P.8
6-2	Concept of detection range	P.8
6-3	Sensor installation recommendations (for Barrier)	P.9
6-4	Sensor installation recommendations (for Swing gate)	P.10
6-5	Sensor installation recommendations (for Slide gate)	P.10
6-6	Installation precautions for specific areas	P.11
6-7	Sensor detection conditions	P.12
7	Installation steps (Basic)	
7-1	Preparation for installation	P.13
7-2	Installation	P.14
7-3	Calibration	P.17
7-4	Detection area check	P.18
8	Check and change settings (How to use the app)	
8-1	Icons	P.20
8-2	App description (Status screen)	P.22
8-3	App description (Parameter screen)	P.23
8-3-1	Main sensitivity	P.24
8-3-2	Fine tuning presence	P.24
8-3-3	Close range sensitivity	P.25
8-3-4	Side approach detection	P.25
8-3-5	Vibration sensitivity	P.25
8-3-6	Sensitivity boost, Sensitivity boost timer	P.26
8-3-7	Relay response time	P.27
8-3-8	Presence detection timer	P.27
8-3-9	Slide gate cancellation	P.27
8-4	App description (Input and output screen)	P.28
8-4-1	Operation indicator	P.29
8-4-2	Heater	P.29
8-4-3	Mode	P.30
8-4-4	Output types and pulse time	P.30
8-4-5	Delay / Hold Timer	P.31
8-4-6	Input	P.32
8-5	App description (Information screen)	P.33
9	Troubleshooting	P.34
10	Specifications	
10-1	Specifications	P.36
10-2	Detection Area Diagram	P.36
10-3	Dimensions	P.37
10-4	Options	P.37

Feature

- Detect the passage and presence of a vehicle with a unique algorithm that uses microwaves (radio waves).
- Setting Adjustments Made with smartphone app.
- Possible to share setting information with others with using the app
- Human Cancellation level is adjustable according to the operation
- Easy-to-see operation indicator (Switchable On / Off)
- Equipped with a heater for snow accretion reduction (Changeable power)



1 Safety precautions

This product is a vehicle detection sensor that detects the entry, presence, and departure of vehicles. Do not use it in any other purpose.



For Safe Use

About the Marks





The description given here is for correct usage of the product without causing damage to you, other personnel as well as damage to properties. The marks and their meanings are as follows: Please read the text after understanding the contents well.

 WARNING	Failure to follow the instructions provided with this indication and improper handling may cause death or serious injury.
 CAUTION	Failure to follow the instructions provided with this indication and improper handling may cause injury and/or property damage.





EXAMPLES OF GRAPHICAL INDICATION

	The △ symbol indicates what you need to pay attention to (including warning). The specific warnings are indicated in the symbol (the figure to the left indicates danger of electric shock).
	The ⊘ symbol indicates prohibition. The specific warnings are indicated in or near the symbol (the figure to the left indicates prohibition of disassembly).
	The ● symbol indicates a compulsory conduct or an item to be observed. The specific instructions are indicated in or near the symbol (the figure to the left indicates that power should be turned off).

WARNING

	Do not touch with wet hands	Do not touch the main unit or the power supply terminal with wet hands (Do not touch them when hands are wet with rain as well). Electric shock may occur.
	Do not disassemble or remodel the unit	NEVER perform disassembly or modification of the unit which is dangerous. Fire or electric shock may occur.
	Turn Off the system power in case of abnormality	Should you use the unit under abnormal conditions if there is smoke or a smell, it may cause fire, electric shock, or burns. Immediately turn off the power and contact the contractor.
	Use the unit within the scope of its specifications	Use the unit within the scope of the specifications designated by this document. The unit will not work properly and fire or electric shock may occur.
	Always turn off the power during installation	Always turn off the unit's power on installation and/or wiring. Electric shock may occur.

CAUTION

	Do not water the unit with high pressure water	Do not water the unit with bucket, hose, and/or high pressure washing machine. Water may get in the unit and cause damage.
	Perform wiring tightly and surely	Follow the steps described in this document for wiring. Fire or electric shock may occur.
	Fix tightly	Follow the steps described in this document when attaching the unit to a pole. The units may fall or its cable may become loose, resulting in injury, fire, and/or electric shock.
	Install and configure the units properly	Follow the steps described in this document for proper installation, configuration, and operation check. It may result in a failure of vehicle detection.
	Regularly clean the unit	Please clean the unit regularly. If you find any abnormality, do not use it.

2 Before using the product

2-1 Detection principle of the sensor

- This sensor uses the reflection of microwave to detect vehicles.
- The microwave sensor uses FMCW technology to detect the presence of a vehicle.

2-2 Sensor operation

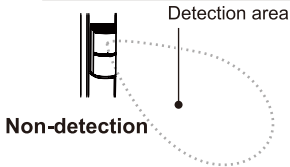

The sensor is a non-detection status when the vehicle is not in the area.

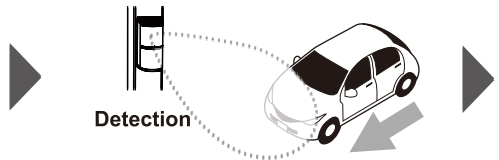

When a vehicle enters the detection area, the sensor will change to a detection status.

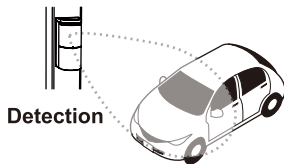

When a vehicle remains in the detection area, the sensor holds a presence "Detection" status.

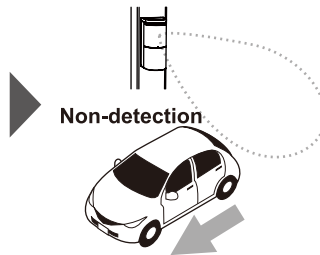

When the vehicle leaves the detection area, the sensor will change to a non-detection status.

NOTE Differences due to vehicle direction

The direction that a vehicle is moving with regards to the sensor affects the detection capability.

Refer to "Sensor Installation Conditions" (pp. 9–11), and install it correctly. Parameters must be adjusted depending on the installation angle, so make sure to install it correctly.

It may be difficult to detect a vehicle that suddenly enters the detection area from a blind angle.

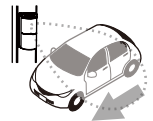

⚠ Caution

- * The following situations may occur due to the sensor detection principles.
- If a pedestrian or an object is in the detection area after a vehicle leaves the area, the sensor will maintain the detection status. The sensor may not change to (or have less of a tendency to change to) non-detection status due to flags, banners, tall weeds, etc.
- If one vehicle tailgates another vehicle very closely when entering the detection area, they may be recognized as a single vehicle.

3 Name of each parts

3-1 Product model number

The product model number denotes the product configuration as follows.
For details, see P36 "10-1 Specifications".

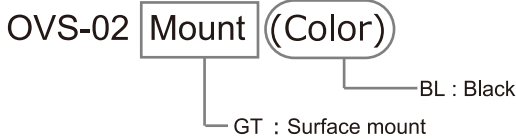

3-2 Unit configuraion

●Surface Mount OVS-02GT

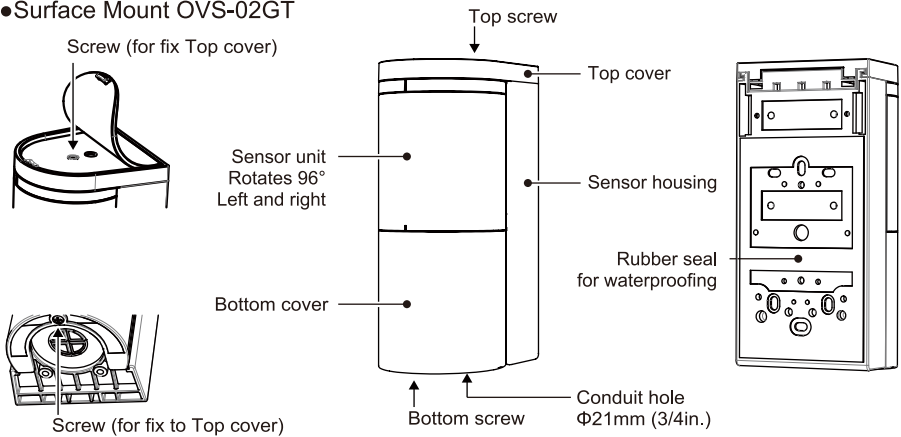

NOTE Maintenance

When the unit body gets dirty, wipe lightly with a damp soft brush or cloth.
If the dirt does not come off, wipe with a cloth dampened with a neutral detergent.



Do not use chemicals such as alcohol.
Do not wash with a high-pressure washing machine.

NOTE Not modifiable

Never perform disassembly or modification of the unit which is dangerous.
Fire or electric shock may occur.
Do not paint or put stickers on the sensor. Ingredients in paint or sticker may influence the sensing performance.

3-3 Sensor unit (Common for all models)

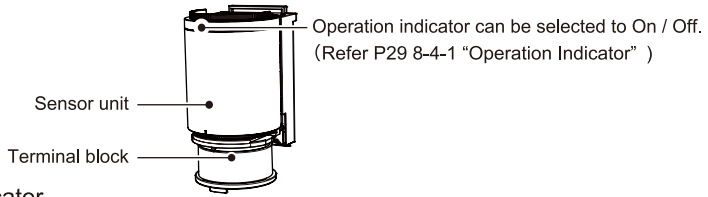

●Operation indicator

Operation mode	Operation status	Status	Operation indicator
Standard operation mode	Standard operation	Standby	Solid Green
		Standby Environmental notification	Solid Purple
		Pre-detection	Solid Yellow
		Detection	Solid Red
		Calibration uncompleted	Solid Blue
	Start up	Start up	Solid Blue (two sec)
Smartphone App connected mode	Standard operation	Standby	Blinking Green(Slow)
		Standby Enviromental notification	Blinking Purple(Slow)
		Pre-detection	Blinking Yellow(Slow)
		Detection	Blinking Red(Slow)
		Calibration uncompleted	Blinking Blue(Slow)
	Area check	Standby	Blinking Green*2
		Pre-detection	Blinking Yellow
		Detection	Blinking Red
	Calibration	In process	Blinking Blue & Green
		Unstable error	Blinking Red & Yellow(Fast)*3
		High reflection error	Blinking Red & Blue(Fast)*3
		High reflection	Blinking Purple*4
Factory reset	Complete	Blinking Blue(Fast)*1	

*1 : Press and hold the reset button for 5 to 10 seconds for the factory reset.

*2 : The operation indicator flashing blue for 30 seconds, it will automatically return to the normal operation mode.

*3 : Calibration has not been performed.

*4 : After blinking for 10 seconds, it returns to the status of Normal operation. Calibration is completed.

*3, 4 : Refer P17 "7-3 Calibration" to fix this issue.

*5 : The operation indicator is always On, even if "Indicator" in App is set to "Off".

●Terminal block

Connect the power cable to the "Power supply" terminals, and relay output cables to the output terminals.

Pay careful attention to output differences, and select output 1 or 2

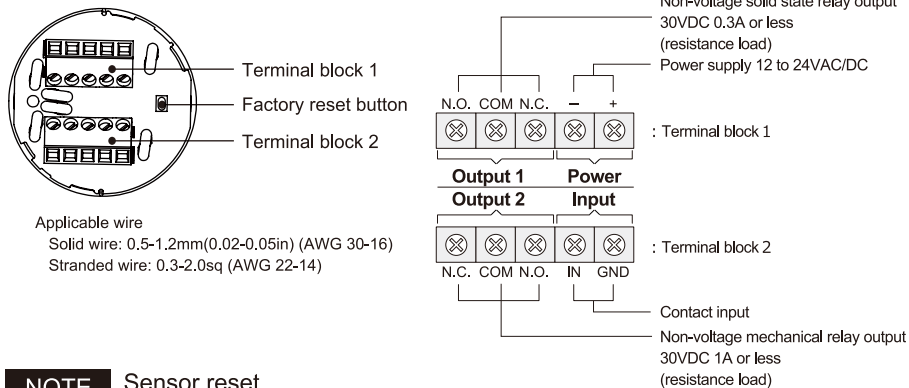

NOTE Sensor reset

All settings including password and calibration value can be returned to the factory default.

If you relocate the sensor, please reset the sensor. Press and hold the factory reset button for 5 to 10 seconds to return for the factory reset. When the reset is completed, the operation indicator lights up in blue for 2 seconds. It is also possible to reset it by selecting the menu item "Reset to factory default settings" in the app.

4 Settings (App)

The OVS-02 series can be programmed using a smartphone. (It can only be programmed by a smartphone.)

* The dedicated App is free of charge, but data fees may be incurred during use.

Before using the App

Before using the App, the following contents should be fully understood.

Be sure to read the terms and conditions and the privacy policy regarding the use of the App, which are indicated in the App.

The App will use the location information, Bluetooth, and camera functions of the smartphone.

Please allow use of these features.

Download the smartphone App from the 2D code or search it with words "OPTEX Virtual Loop" at AppStore or GooglePlay.



 OPTEX VirtualLoop

1 Log in to the App

After starting the App for the first time and consenting to the terms and conditions, the screen to set an App user will appear.

Entry is optional. After you input a user, the "Sensor list" screen will be shown.

You can edit the entered information at any time.

After updating the sensor settings, the user will be displayed as an administrator within that App.

2 Log in to the sensor

When logging into a sensor for the first time, set a login password on the sensor while referring to the cautions below. Manage passwords carefully to avoid breaches and loss.

Passwords can be changed.

If a password is lost, press and hold the reset switch for more than 5 seconds to reset the sensor to its factory settings.

3 Share the Favorite

• When not connected to the sensor

From the ☆ icon on the "Sensor list" screen, saved Favorites can be shared.

• When sharing the settings of the sensor being set

Settings can be shared from the 2D code icon on the "Parameter list" screen.

4 Register shared Favorite

You can read the 2D code from the 2D code icon on the "Application and Favorite setting" screen.

To read a 2D code image that has been saved onto a smartphone, select the Folder icon.

Caution

* When setting a password, refer to the following points, and determine a password that will not be easily guessed by others.

- A string from the sensor ID (as is, reversed, repeated, etc.)
- Passwords that can be guessed from the installation site or the company name (e.g. post code, address, telephone number, company name, etc.)
- Consisting entirely of the same number or letter.
- Simple numerical or alphabetical sequences (e.g. 123456)
- A word from a dictionary

5 Installation steps

Chapter 6

Verify the sensor installation conditions

P.9, 10

Create an installation diagram

Record the sensor name and installation layout and keep them in a safe place.

Drilling holes in the installation area

P.13

Chapter 7

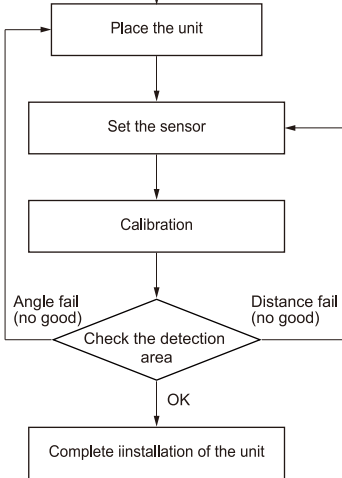

P.14 to 16 *Angle adjustments can be made
When using Input/Output, go to **P.28 - 32**

Use smarhtone app

P.6, 8
When no good, go to **P.28 - 32**

P.17

P.18, 19

P.16

Record the sensor name and password and keep them in a safe place.

6 Preparation before operation

6-1 Applications

• Select the application that matches how the sensor is to be used. Do not use the product for purposes other than the selectable applications. Some models are not suitable for some applications.

Barrier - Activation : Opening a barrier / activating a gate system

Barrier - Protection : For vehicle protection

Slide gate - Activation : Opening a slide gate / activating a gate system

Slide gate - Protection : For vehicle protection

Swing gate - Activation : Opening a swing gate / activating a gate system

Swing gate - Protection : For vehicle protection

Swing gate - Shadow : Preventing a swing gate from closing

*This application is called as Shadow loop or Center loop.

6-2 Concept of detection range

- Be sure to set the installation angle and detection range according to the installation conditions.
- The installation angle and corresponding layout for each application are shown below.

Recommended setting

Detection range = Road width - 1.5m (5')

Application	Angle	
Barrier - Activation	90°	45°
Barrier - Protection	90°	45°
Slide gate - Activation	90°	45°
Slide gate - Protection	90°	45°
Swing gate - Activation	90°	45°
Swing gate - Protection	90°	45°
Swing gate - Shadow	90°	45°

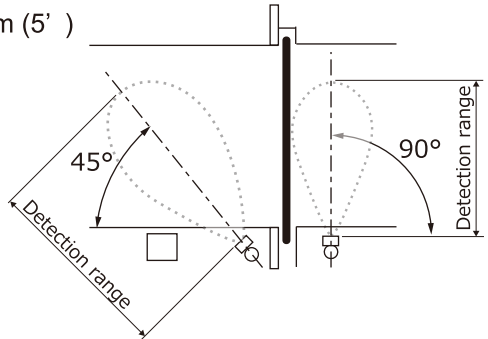

NOTE Detection range when installing at 45°

When installing at 45 degrees, set the detection range by referring to the table below.

Road Width	Detection range setting
2.5m (8.2ft.)	2.5m (8.2ft.) or less
3.0m (9.8ft.)	3.0m (9.8ft.) or less
3.5m (11.5ft.)	4.0m (13.1ft.) or less
4.0m (13.1ft.)	4.5m (14.8ft.) or less
4.5m (14.8ft.)	5.5m (18ft.) or less
5.0m (16.4ft.)	6.0m (19.7ft.) or less
5.5m (18ft.)	7.0m (23ft.) or less
6.0m (19.7ft.)	7.5m (24.6ft.) or less
6.5m (21.3ft.)	8.0m (26.2ft.) or less
7.0m (23ft.)	Install as 90°

- After configuring the settings, check the performance with an actual vehicle (refer to pp. 18–19).

6-4 Sensor installation recommendations (for Slide gate)

Install the sensors with the layout shown below.

When the installation direction or installation height is improper, the sensor will not operate properly.

- The sensor angles shown below are for vehicles entering parallel to the drive way. The sensor angle should match the angle of the vehicle (not the drive way).

Installation height : The bottom of the sensor is 500 mm (20in.) from the ground

*1 : Setting a distance greater than recommended may create non-detection area between the activation and protection sensor.

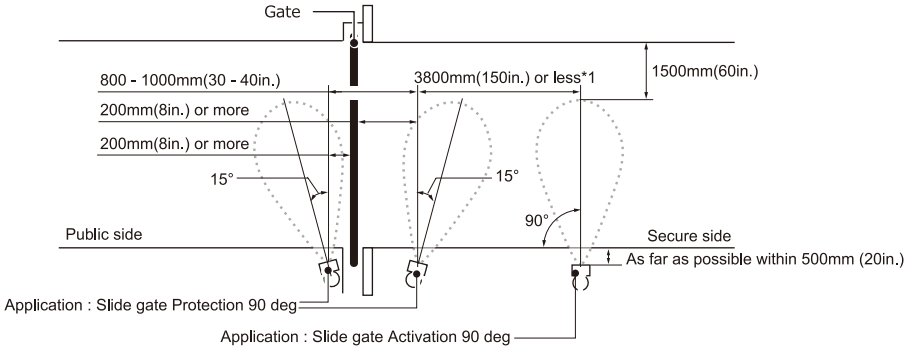

6-5 Sensor installation recommendations (for Swing gate)

Install the sensors with the layout shown below.

When the installation direction or installation height is improper, the sensor will not operate properly.

- The sensor angles shown below are for vehicles entering parallel to the drive way. The sensor angle should match the angle of the vehicle (not the drive way).

Installation height : The bottom of the sensor is 500 mm (20in.) from the ground

*1 : Setting a distance greater than recommended may create non-detection area between the activation and protection sensor.

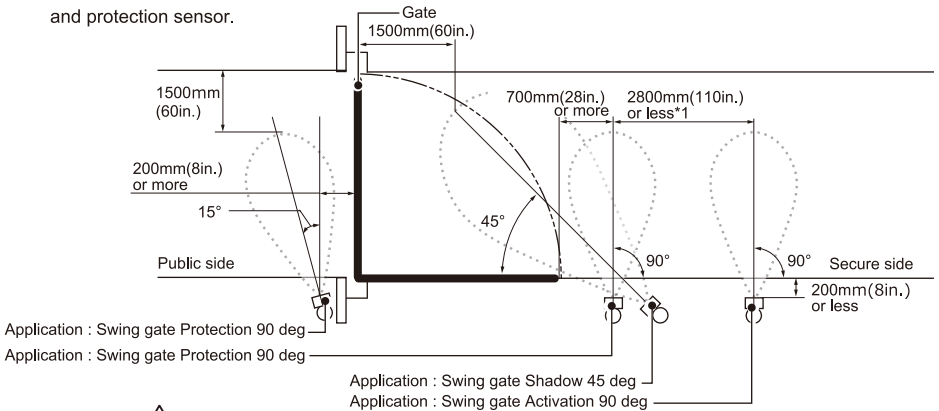

⚠ Caution

- When 45 degree setting is set, it may not detect vehicles moving away from the sensor because it is more sensitive to approaching objects. Therefore, the sensor may not detect a vehicle which is backing up to the detection area.



6-6 Installation precautions for specific areas

1 Tilted pole

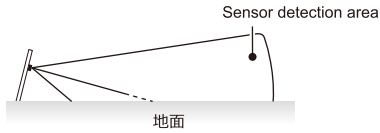

If the sensor is installed on a tilted pole, it will see the ground and not operate properly. Make sure to install the sensor on a pole that is vertical to the ground.

2 Sloping ground

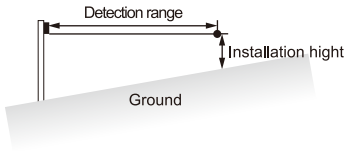

If the pole cannot be installed vertically because of sloping ground, etc., install it in a position such that it is 500mm (20in.) above the ground at the set detection range (depending on the application).

However, the detection capability may be reduced as compared to a sensor installed vertically to the ground.

2 Other surrounding environment

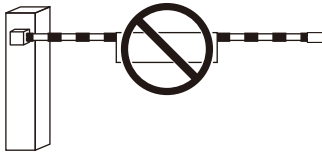

- There should not be irregularity on the ground in the sensor's detection area such as gratings (refer to "12-2 Detection Area Diagram" (p. 41)). In such a place, the sensor may not go into the non-detection status or may be slow to change to that status.
- Do not install any moving object such as flags or banners in the correct space detection area. Remove any vegetation from the detection area, or reconfigure the detection area to be smaller. In such a place, the sensor may not go into the non-detection status or may be slow to change to that status.
- Do not use a fluorescent lamp around the detection area. It may prevent proper operation of the sensor.

6-7 Sensor detection conditions

- Below are the conditions that vehicles must satisfy to be detected by the sensor.

Vehicle length: 3300mm (130in.) or more,
5000mm (197in.) or less

Vehicle width: 1400mm (55in.) or more,
1900mm (75in.) or less

Vehicle height: 1200mm (47in.) or more,
2100mm (83in.) or less

Minimum ground clearance: 150-250mm (6-10in.) or more

Total vehicle weight: 2.5t (5512lb.) or less

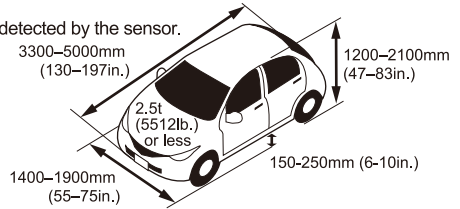

- Vehicles approaching at 2-35km/h (1.2-22mi/h) are detected.

⚠ Caution

* The following cases may occur due to the sensor's characteristics.

- The sensor may not work properly if it is installed in a location that does not meet the installation conditions.
- The sensor may not work correctly if it is not installed in accordance with the instructions in this manual.
- Pedestrians, bicycles, or any large object (especially metal) entering the detection area may be detected.
- Depending on the position and/or direction of vehicle approach, the distance to be detected may become shorter or may not be detected.
- Performance of the sensor may be affected if:
 - The sensor pole is not vertical from the ground
 - The sensor surface is covered with ice, snow, chewing gum, dirt, etc.
 - A sensor unit is frozen
 - Snow has accumulated over a specified height in the sensor's detection area
 - It is raining heavily
 - Water splash is on a sensor

7 Installation steps (Basic)

7-1 Preparation for installation

■ Required Tools ■

● Small screwdriver, Phillips #1

● Screwdriver, Phillips #2

- On a square pole or a wall, drill holes to install the unit as shown below. If tapped holes cannot be made, make pilot holes of $\phi 4.3\text{mm}$ (0.17in.), and secure the unit using nuts. After making holes, deburr the surface to preserve the waterproof property.
- When mounting the unit directly to a wall using tapping screws, consider its effect, and take appropriate actions, such as making pilot holes, according to the target material. We cannot be held liable for any negative effect on the target material.

[Unit : mm (in.)]

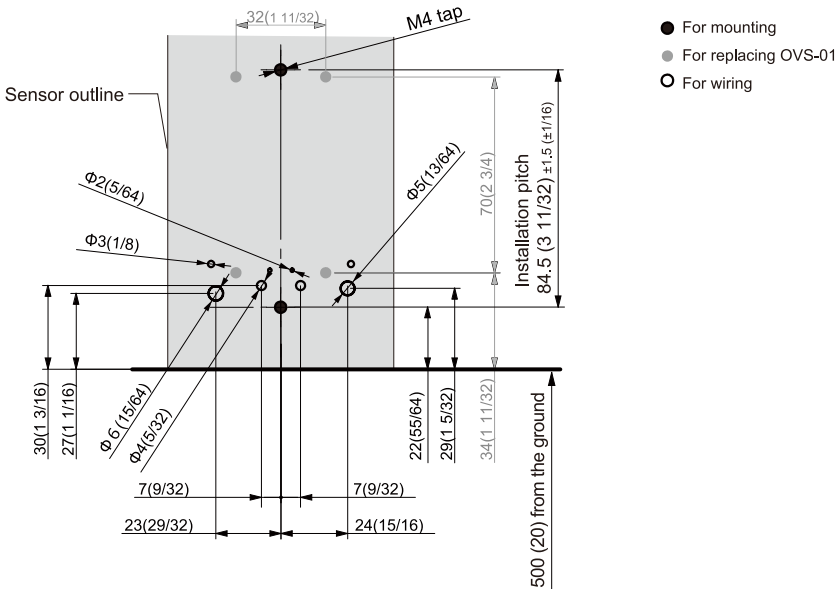

7-2 Installation

[1] Loosen the screws on the top and bottom covers, and remove the covers.

* Do not loosen the screws completely. The screws may fall out.

If a screw is lost, use an M3 × 6 Philips screw.

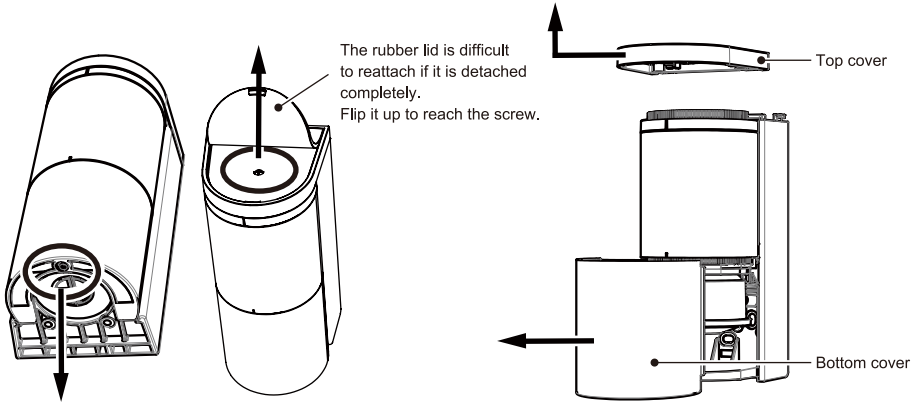

[2] Detach the sensor unit by lifting it.

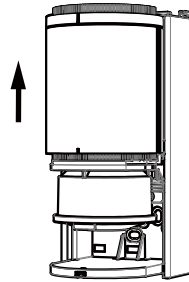

NOTE When using a conduit pipe

When using conduit pipes, break the knockout on the bottom of the base, and run wires.

Use a hard sharp tool such as a driver to break the knockout.

If it is difficult to remove the remaining debris, use pliers, etc.

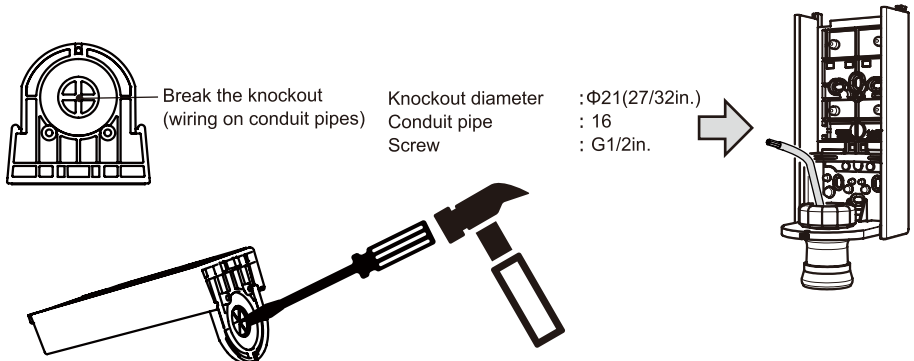

[3] When running a wire from a pole, cut the terminal cover with nippers by referring to the wiring holes on page 13, and put wires through the sensor housing.

Do not use a powered screwdriver when mounting the unit to a pole.

● Round Pole

Adjust the position so that the front of the base faces the desired angle, and mount it to the pole.

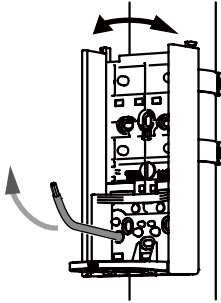

● Square Pole

When pilot holes of $\phi 4.3\text{mm}$ (0.17in.) have been made, use M4 screws (included) and nuts (not included) for mounting.

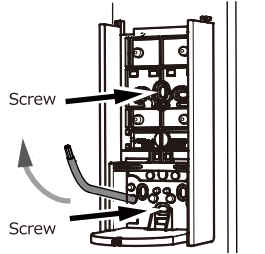

[4] Connect wires to the terminals. Refer to page 6

Connect the power cable to the power supply terminals, and relay output cables to the output terminals.

When linking to other devices, connect the other device to the input terminals.

Cut the terminal cover with scissors and make a hole according to the wire diameter. (Select the smallest from among similar sizes.)

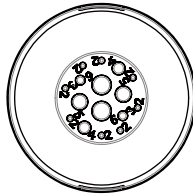
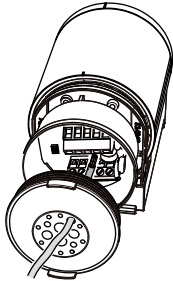

Wiring size : $\phi 2$ to 6mm
(3/32 to 1/4in.)

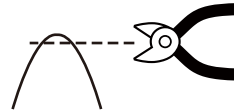

Only cut the tip using nippers.
This will avoid making a hole too big.

⚠ Caution

- Do not pull the cable. It may cause the terminal cover to come off and allow water to leak in.
- If a hole with wrong diameter is made
Apply silicon adhesive and fill the hole. When doing so, be careful not to overfill the adhesive over the hole.
If the hole is not filled, water may leak in and it may result in breakage.

- [5] Install the sensor unit into the sensor housing.
At this point, push excess wire out on the pole side.

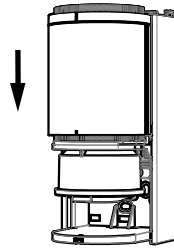

- [6] Rotate the sensor unit to adjust its angle to meet the sensor installation condition (adjustable angle: 96° to left and right).

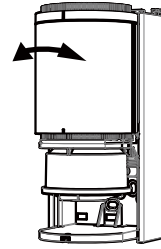

Log in to the sensor with smartphone App

- [7] Verify the detection area according to "6-1.Applications" "6-2.Concept of Detection Range" (p.8)
[8] Perform calibration according to "7-3. Calibration" (p.17)
[9] Verify the system operation according to "7-4. Detection area check" (p.18).
[10] If necessary, set various parameters referring to P21 and more

Log out from the sensor with smartphone App

- [8] Attach the top and bottom covers.

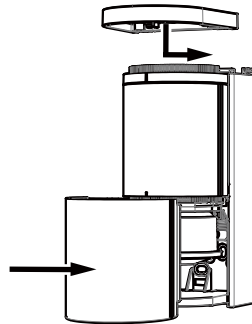

- [9] Tighten the screws on the top and bottom covers.
* If a screw is lost, use an M3 × 6 Philips screw.

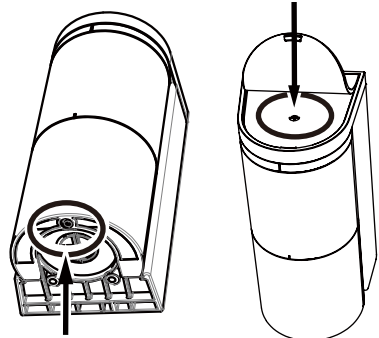

7-3 Calibration

1 Calibration function

This function memorizes the background of the detection area when no pedestrians or vehicles are present. This function ensures the stability of vehicle detection by recording the environment. Perform calibration after every sensor installation.

This process makes the sensors performance higher and more stable.

2 How to perform calibration

[1] Verify that there are no vehicles, pedestrians, work tools, or any other temporary objects which may be removed in the detection area. If anything is present, remove it from the detection area.

[2] Press the Calibration button in the App and confirm that the screen has changed to the “Calibrating” screen.

The operation indicator blinks alternately in blue and green during calibration.

(3) When the calibration is completed, the screen in the App changes, and the operation indicator blinks in green (slow).



NOTE Performing calibration properly

- Perform calibration after every sensor installation.
- It must be performed without vehicles, pedestrians, work tools, or any other temporary objects which may be removed in the detection area.
- If a vehicle or pedestrian enters the detection area during the calibration, try again.
- If any noticeable changes occur around the detection area (such as construction of a wall or fence), you must perform calibration again.
- If the sensor's installation height or settings have been changed after the calibration, perform calibration again.

3 Forced termination of calibration

Calibration stops automatically in up to 10 seconds. If an error message is displayed and the operation indicator blinks in green (slow), refer to the following to remove the cause.

NOTE Error while calibration

- The operation indicator blinks purple : Microwave reflection in the detection area is too high. In this case, calibration is performed, but detection performance may be degraded. Calibration will be performed, but detection performance may be degraded.
- The operation indicator blinks alternately in red and blue (fast) : Microwave reflection in the detection area is extremely high. In this case, calibration is not completed due to an error.
- The operation indicator blinks alternately in red and yellow (fast) : If the sensor reacts during calibration, a calibration error occurs. Calibration error occurs if the sensor reacts during calibration. In this case, calibration is not completed due to an error.
- The error may be caused by the following. Remove the cause of the error and perform calibration again. If the problem is not resolved, refer to “10-2 Detection Area” (p. 36) to reduce the sensor's detection range.
- The sensor detects an object such as a wheel stopper, or a pedestrian in the detection area.
- The sensor is installed too low and detects the ground.
- The sensor pole is tilted and the sensor detects the ground.
- The sensor installation direction is not correct, and the sensor is detecting a close vehicle or wall (fence).

7-4 Detection area check

1 Detection area check

This function allows you to virtually check the invisible detection area using indicators on the App or the operation indicator.

It is possible to verify the correct angle and size of the detection area.

During this process, the human cancellation function is disabled, and any moving objects can be detected.

* Be sure to perform the area check after transmitting the settings and performing calibration.

2 How to check the detection area

(1) On the "Status" screen of the App, turn On the area check mode and tap Send icon . The mode changes to detection area check mode, and the operation indicator blinks in green. If the operation indicator blinks yellow even when there are no people or objects in the detection area, perform calibration again.

(2) Perform steps [1] and [2] on the next page.

(3) After checking the detection area, On the "Status" screen of the App, turn Off the area check mode and tap Send icon . The mode will switch to the normal operation mode and the operation indicator will change back to blinking in green (slow).

* If it keeps blinking in green (non-detection status) for 30 seconds, it will automatically change back to normal operation mode.

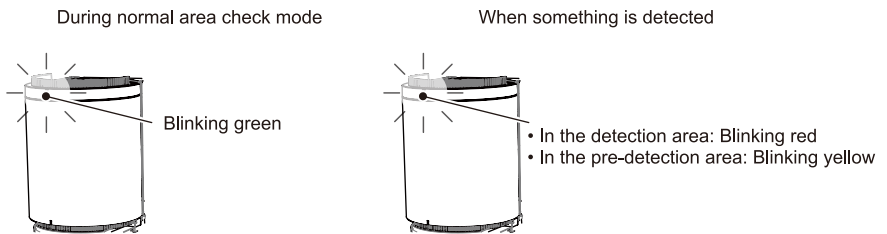

* Delay / Hold timer settings are not applied during the detection area check mode.

NOTE Corresponding to malfunction in the area check mode

-The sensor may not work properly when there is a large metal body such as a shutter in the detection area or when the immediate area of the sensor is covered. In such a case, the operation indicator turns on purple when the sensor is in standby status to indicate that it is in an unfavorable environment.

- When the operation indicator turns on purple, check the condition in the detection area and remove the cause by removing metal objects from the surrounding area.

Caution

- If the sensor is detected (not detected) in an unexpected location in the area check mode and the sensor installation angle or detection range is reset, be sure to perform calibration after resetting the detection area and adjusting the angle of the sensor.

[1] Check inside the detection area

Stand at the center of the vehicle lane (position [1] in the figure below) and walk in the direction of vehicle access. The position where the operation indicator changes from blinking green to blinking red (detection status) is the edge of the detection area. (In normal operation mode, the detection area may be a little bit longer.)

If the detection area is not as expected, adjust the space incorrect installation direction and/or the detection range again.

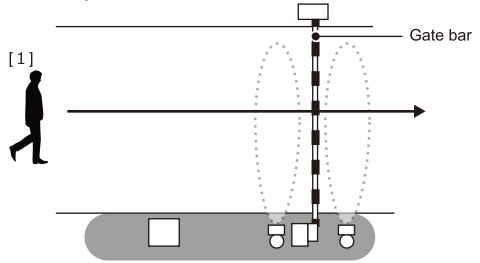
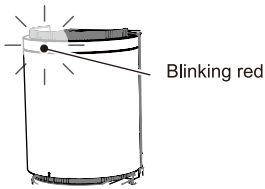

[2] Check outside the detection area

Stand at the edge of the vehicle lane (position [2] in the figure below), walk along the border and verify that it stayed in non-detection status. (Operation indicator blinks in blue.)

If the operation indicator blinks in a color other than blue (detection status), adjust the sensor's installation direction and/or detection range, and restart from [1].

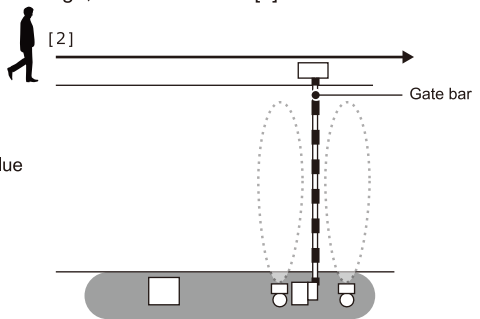
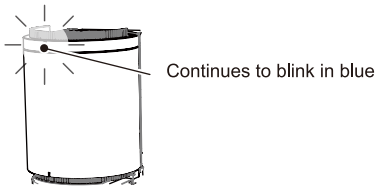

3 System operation check

After verifying the detection area, use a vehicle to check the entire operation of the parking space devices.

For the operation check, verify proper operation with a vehicle parked on the left side, center, and right side of the lane.

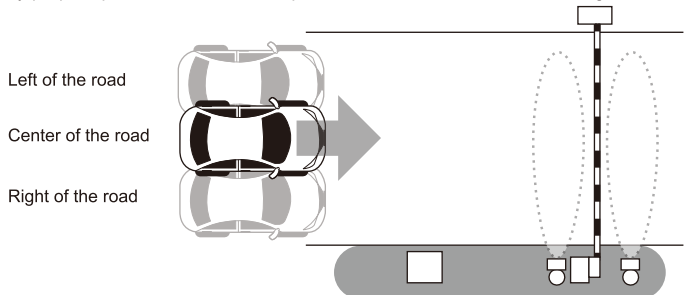

8 Check and change settings (How to use the app)

8-1 Icons

Below are the icons used in the App.



2D code : This is used to log in to the sensor, or to share Favorites.



Folder : This is used to read a 2D code that has been saved onto a smartphone.



Save : This is used to save 2D codes and Favorites.



Send : This is used to transmit settings to the sensor.

If a red circle appears on the top right of the icon, make sure to press this.



Status : This is used to verify sensor operation. If a red circle appears on the top right of the icon, make sure to perform the “Send” operation.



Parameter : This is used to set sensor parameters. If a red circle appears on the top right of the icon, make sure to perform the “Send” operation



Input and output : This is used to set sensor inputs and outputs. If a red circle appears on the top right of the icon, make sure to perform the “Send”



Information : This is used to verify or edit sensor information.



Share : This is used to share Favorites with others.



Add : This is used to add a Favorite.



Delete : This is used to delete Favorites.



Signal strength : This indicates the strength of signals transmitted between the sensor and the smartphone.
If the signal strength is low, approach the sensor and perform setting.



Menu : The items shown below are displayed.



Save/Share setting : Current settings can be checked, saved and shared.



Favorite : This is used to check Favorites and reflect them to the settings.



Back to previous setting :

This returns changed settings (items displayed in red) to the previous settings.
Once a setting is transmitted to the sensor, it cannot be reverted.



Reset to factory settings :

This resets the settings to their factory defaults.

Be cautious when using this, as settings and information will be deleted.



Manual (web): This displays the instruction manual on the website.
(Telecommunication fees may be incurred.)



Terms and conditions : This displays the terms and conditions.



Privacy policy : This displays the privacy policy on the website.
(Telecommunication fees may be incurred.)



Copyright notice : This displays the copyright notice.



User info : User information and language can be changed.



Logout : This terminates the connection to the sensor unit.

If any items have not been sent to the sensor, be sure to tap the send button and update the sensor settings before logging out.

After applying the settings, log out and terminate the connection.

8-2 App description (Status screen)

- Check and set the sensor status.

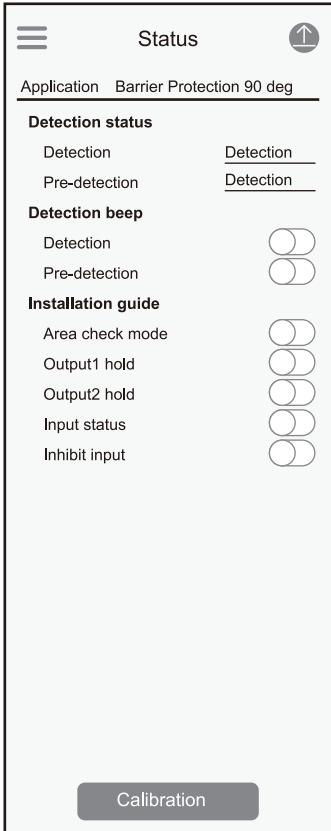

■ Applications

Change it by selecting Menu Icon > Favorite > Select application.

● Detection status

[1] Detection

This indicates the detection status of the sensor. (Updated approximately once per second.)

[2] Pre-detection (Area check)

This indicates whether the sensor has started a detection response or not. (Updated approximately once per second.)

● Detection beep

[3] Detection

[4] Pre-detection (Area check)

A beep sound is made when the detection (pre-detection) status changes.

● Installation guide

[5] Area check mode

When this is On, the sensor detects moving objects such as vehicles and pedestrians. Use this for checking the area.

If the operation indicator keeps blinking in blue (non-detection status) for 30 seconds, this will automatically change back to normal operation mode.

[6] Output hold

Outputs from the sensor can continuously be On. Use this for checking the system operation while outputs are active.

[7] Input status

Inputs can continuously be On. Use this for checking the system operation while inputs are active.

[8] Inhibit input

The sensor will keep operating without changing its operation even if it receives inputs. Use this for checking the system operation while inputs are not active.

* Installation guide items will be automatically turned Off when a user logs out from the sensor, or when the connection between the sensor and smartphone is lost.

NOTE Detection and Pre-detection

“Detection” indicates the space incorrect detection status. Use this as a check for actual operation.

“Pre-detection” indicates if the sensor has captured an object. If there are no vehicles, people, or other objects in the detection area, but “Pre-detection” is still detected, there may be a problem with the sensor orientation or settings, or there may be a false factor in the surrounding environment.

⚠ Caution



- After changing settings, be sure to tap the Send icon to send the settings to the sensor.

Calibration

- Perform this if the operation is unstable, or there is a false detection or loss of detection.

- Please perform this when there are no vehicles or objects in the surrounding.

8-3 App description (Parameter screen)

- Check and change the sensor parameters.

Parameter 	
Application	Barrier Protection 90 deg
Detection range	<u>3,5m (11.5')</u>
Main sensitivity	<u>Lv.2</u>
Fine tuning presence	<u>Lv.4</u>
Close range sensitivity	<u>Lv.2</u>
Side approach detection	<u>On</u>
Vibration sensitivity	<u>Off</u>
Sensitivity boost	<u>Off</u>
Sensitivity boost timer	<u>Off</u>
Relay response time	<u>Lv.1</u>
Presence detection timer	<u>15min</u>
Slide gate cancellation	<u>Lv.1(Low)</u>

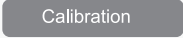

■ Applications

Change it by tapping Menu Icon > Favorites > Select application.

- [1] Detection range
Refer to page 8
- [2] Main sensitivity
Refer to page 24
- [3] Fine tuning presence
Refer to page 24
- [4] Close range sensitivity
Refer to page 25
- [5] Side approach detection
Refer to page 25
- [6] Vibration sensitivity
Refer to page 25
- [7] Sensitivity boost
Refer to page 26
- [8] Sensitivity boost timer
Refer to page 26
- [9] Relay response time
Refer to page 27
- [10] Presence detection timer
Refer to page 27
- [11] Slide gate cancellation
Refer to page 28

Caution



- After changing settings, be sure to tap the Send icon to send the settings to the sensor.

 Calibration

- Perform this if the operation is unstable, or there is a false detection or loss of detection.
- Please perform this when there are no vehicles or objects in the surrounding.

The following setting items should be configured if the sensor does not operate as expected during a system operation check or if an error occurs. These do not need to be set for normal installation. Change the settings as required using the App.

8-3-1 Main sensitivity

This parameter adjusts the sensitivity of detection when a vehicle enters the detection area. The detection and the false detection avoidance capability have the relationship shown in the figure below.

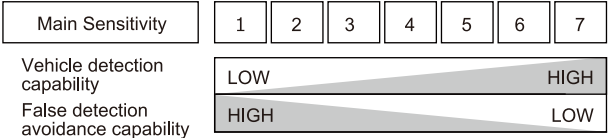

NOTE This may need to be changed if:

- This needs to be increased : Sometimes a vehicle is not detected.
Detection response is too slow.
- This needs to be decreased : Pedestrians are detected.

8-3-2 Fine tuning presence

This parameter adjusts the sensitivity to switch to the non-detection status when a vehicle leaves the space, leaving the space empty. The presence detection and the tailgating avoidance capability have the relationship shown in the figure below.

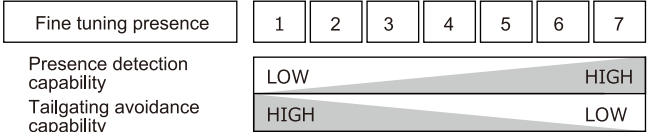

NOTE This may need to be changed if:

- This needs to be increased : Even though there is a vehicle, it is not kept detected.
- This needs to be decreased : Even though the vehicle is left, it is still detected.
tailgating may occurs.

NOTE Tailgating

This term refers to unauthorized entry following a vehicle that has entered properly. When two vehicles come closer in a row and the sensor could not determine the gap in between, it detects as one vehicle. This is a situation for tailgating.

8-3-3 Close range sensitivity

This parameter adjusts the sensitivity of close range 100-500mm (4-20 in.) from sensor when a vehicle enters the detection area. The vehicle detection capability (close range) and the false detection avoidance capability have the relationship shown in the figure below.

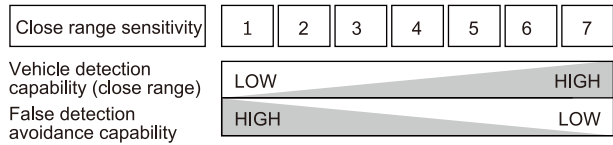

8-3-4 Side approach detection

This function could be used only for 90 degree setting. And it could enhance the sensitivity for a vehicle which approaches from side.

8-3-5 Vibration sensitivity

This parameter adjusts the ability to keep detecting when a vehicle is detected. The capability to keep detecting vehicles in the detection area and the capability to avoid false detection due to rain, snow, tailgating and etc. have the relationship shown in the figure below.

In general, even with EV creating some vibration, so this function could enhance the sensitivity for the vibration.

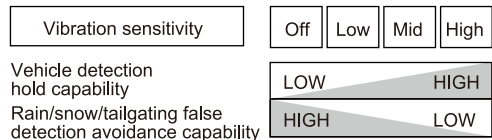

NOTE This may need to be changed if:

- This needs to be increased : Even though there is a vehicle, it is not kept detecting.
- This needs to be decreased : False detection due to rain or snow occurs or tailgating happens a lot.

8-3-6 Sensitivity boost, Sensitivity boost timer

This can be used to avoid contact between vehicles that move backwards soon after passing under a barrier and the descending barrier arm.

By enabling this function, sensitivity is increased for a set time period to detect backward-rolling vehicles more easily. Enable this function if vehicles may roll backward unintentionally due to a rising slope at a parking lot exit.

* This function cannot be used in gate systems that do not have a reverse function.

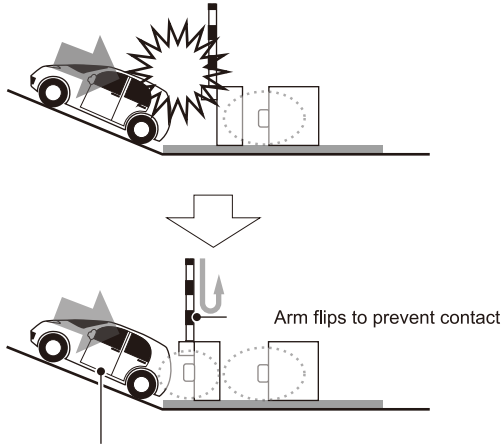

After the sensor is not detected, increase the sensitivity for the set time, Make it easier to detect vehicles that are moving backwards.

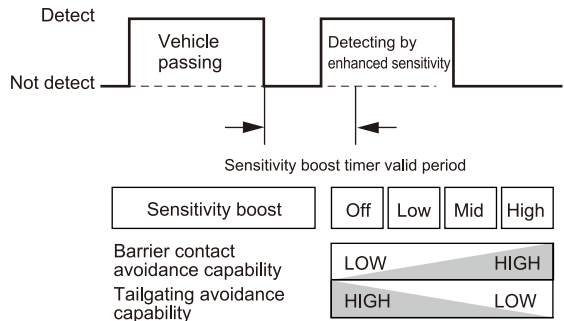

NOTE Caution on usage

- At parking lot exits where vehicles tend to clog, set the sensitivity boost timer longer as required.
- In order to prevent the sensor entering non-detection, set the off-delay timer to be longer. However, making it longer makes the response time longer, so take care when adjusting this.
- While sensitivity boost is enabled, vehicles, pedestrians, and other objects are more likely to be detected.

8-3-7 Relay response time

This parameter adjusts the recognition time of the sensor.

The response time and the false detection avoidance capability have the relation shown in the figure below. Also it effects for human cancellation capability.

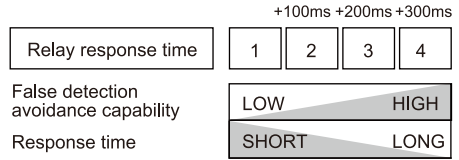

NOTE This may need to be changed if:

- This needs to be increased : Pedestrians are sometimes detected.
- This needs to be decreased : Sometimes a vehicle is not detected.
Higher speed vehicle is not detected.

8-3-8 Presence detection timer

The presence detection timer starts calibration regularly, regardless of the detection status.

This prevents continuing false detection by the sensor when the ambient condition changes.

NOTE This may need to be changed if:

- This needs to be increased : Vehicles are prone to stay long in the detection area.
- This needs to be decreased : The sensor is kept detected by some ambient condition.

8-3-9 Slide gate cancellation

This parameter adjusts the function to prevent false detection when a slide gate closes. By setting it On, the sensor could ignore the closing slide gate more. If it sets to On, a vehicle entering to slide gate with some angle might not be detected more.

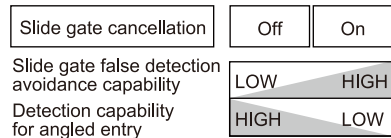

8-4 App description (Input and output screen)

- Check and change the input / output settings of the sensor.

☰ Input and output 

Application Barrier Protection 90 deg

Indicator

Indicator

Heater

Heater Normal

Output 1

Mode Detection

Output type Pulse IN

Pulse time duration 150ms

Delay 0.5s

Hold timer 0.5s

EOL Off

Output 2

Mode Detection

Output type Pulse IN

Pulse time duration 150ms

Delay 0.5s

Hold timer 0.5s

RS485 channel 0

RS485 baud rate 0

RS485 EOL 0

RS485 protocol 0

Input

Mode Link(OR gate)

Contact High

■ Applications

Change it by selecting Menu Icon > Favorite > Select application.

● Indicator

[1] Indicator

Refer to page 29

The operation indicator is lit when the sensor makes a detection during operation. The operation indicator can be selected to On or Off.

● Heater

[1] Heater

Refer to page 29

Normally set this to Normal.

● Output

[3] Mode

Refer to page 30

[4] Output type

Refer to page 30

[5] Pulse time

Refer to page 30

[6] Delay

Refer to page 31

[7] Hold timer

Refer to page 31

● RS485 (GT model does not use)

[8] RS485 channel

[9] RS485 baud rate

[10] RS485 EOL

[11] RS485 communication protocol

Set according to the connected device.

● Input

[12] Mode

[13] Contact

Set according to the connected device.

 Caution



- After changing the settings, tap the send icon to send the settings to the sensor.

8-4-1 Operation indicator

The operation indicator can be selected to On or Off from the App. Set it from the "Indicator" item on the "Input and output" screen. The operation indicator is always On while connected to the App.

- Operation indicator On / Off function
- From the "Input and output" screen of the App
- Hold a magnet close to the operation indicator to toggle indicator On and Off (only when not connected to the App)

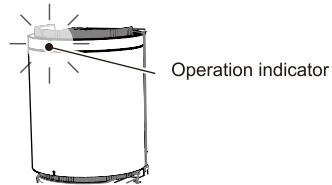

8-4-2 Heater

To minimize the influence of frost and snow, the sensor unit has a built-in heater. The heater is automatically activated when the external temperature drops to 5°C (41°F) or lower. (The heater is automatically deactivated when the external temperature reaches 5°C (41°F) or higher.)

The heater can be selected to be active or inactive from the App. Set it from the "Heater" item on the "Input and output" screen.

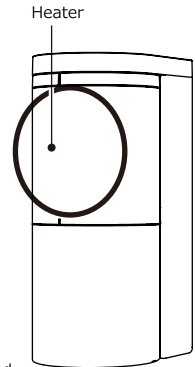

Heater	Off	Normal	High
Heater power	LOW  HIGH		
Power consumption	90mA	220mA	300mA

*Power consumption is the maximum value when 24VDC is used

8-4-3 Mode

Signals can be selected according to the application of the output signals.
Refer to the section below and make a selection.
Detailed settings can not be made for modes other than "Detection".

Detection : A normal detection.

(The output state reflects the setting of Output delay, Hold timer and others.)

Pre-detection : Outputs a pre-detection and a normal detection both.

(The output state does not reflect the setting of Output delay, Hold timer and others.)

Mask: This is a function to send a relay output when the sensor surface is blocked by something by vandalism and it effects to the performance of the sensor. Once the sensor is masked for more than 30 seconds, it starts sending a relay output. Also if it recognizes it stopped masked for more than 10 seconds, it stops sending the output.

8-4-4 Output types and pulse time

Output methods can be selected according to the connected devices.
Normally select "Holding".

Signal characteristics for each type are shown below.

When "Pulse" is selected, the pulse time (signal width) can be adjusted.

Holding : Outputs of detection signals are held during detection.

Pulse IN : A signal is output only when a detection occurs. The pulse time can be adjusted.

Pulse OUT : A signal is output only when the detection status switches to non-detection.

The pulse time can be adjusted.

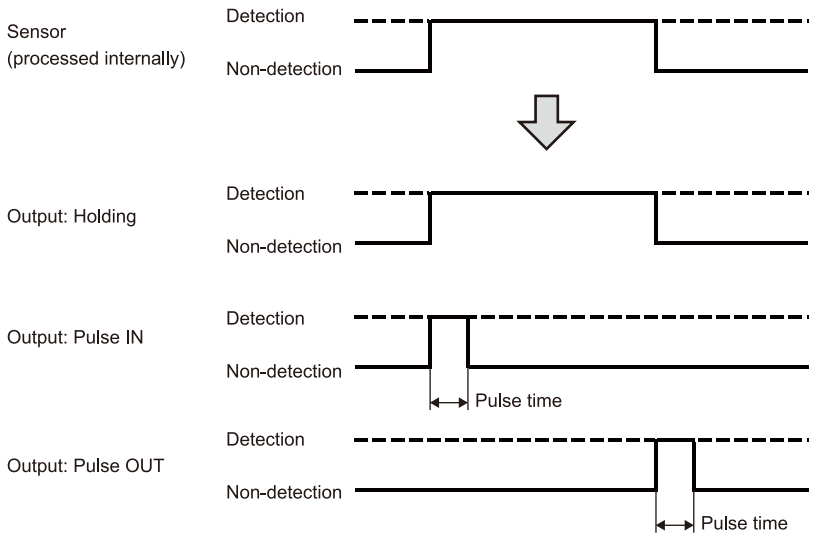

8-4-5 Delay / Hold Timer

Delay / Hold timer is the time between the sensor status change and the relay output change. Setting the timer shorter makes the response time faster.

Note that detection also needs a response time, which is the time for the sensor to recognize an object and make the detection, separately from the timer time.

Delay : Delay time from actual detection to relay output

Hold timer : Delay time from non-detection to the relay output turning off

Delay	Off	0.5	1	2	3	4		
Hold timer	Off	0.5	1	2	3	10	30	60
Detection stability	LOW						HIGH	
Responsiveness	HIGH						LOW	

e.g.) Delay: 0.5s, Hold timer: 1s

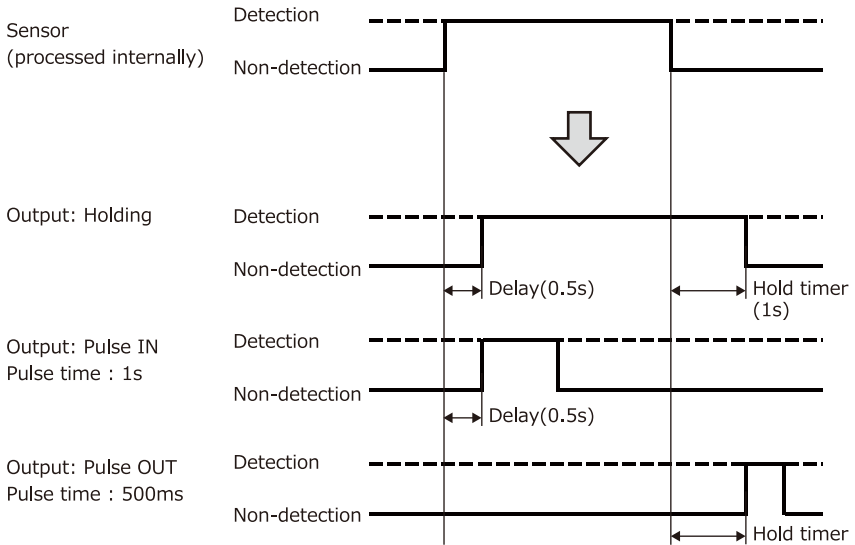

NOTE

This may need to be changed if (when output type is Holding):

- The timer needs to be set shorter : When a quick response is required
- The timer needs to be set longer

Delay : Even if the sensor momentarily enters detection status in an unsuitable environment, such as with high pedestrian traffic, this prevents the relay output from changing to On and provides stable detection.

Hold timer : Even if the sensor momentarily enters non-detection status in an unsuitable environment, such as during heavy rain, this prevents the relay output from changing to Off and provides stable detection.

8-4-6 Input

By inputting signals from other devices, outputs linked to other devices can be made.

Change contacts according to the connected devices.

Connect signals lines from a startup sensor or controller to the input terminals.

Application : Link (OR gate, AND gate)

When operating a charging system, the reliability can be increased by using inputs from an external device.

Application : Inhibit

Sensor outputs can be disabled when it has inputs from an external device.

Application : Wake

Possible to use an external input to maximize the sensitivity.

8-5 App description (Information screen)

- Check and change the information.

Info	
Application	Gate - Activation
Sensor info	
Name of sensor	Parking1
Password management	*****
Location info	35.09, 135.91
Site name	OParking
Version info	
Software	1.0
Firmware	1.0
Access info	
Number to log in	2 times
Previous log in	2021/07/22
Nickname	OPlivia
Belongs	OPTEX
Last update	2021/05/25
Nickname	OPliam
Belongs	OPTEX
Operation info	
Operation duration	168days 1h
Total number of times for detection	1979525times

■ Applications

Change it by selecting Menu Icon > Favorite > Select application.

● Sensor information (Editable)

[1] Name of sensor

The sensor name that was set at the first log in is displayed

The name of the sensor will be added before the unique sensor serial ID from the second login.

ex.) "Name of sensor" + "Sensor serial ID"

[2] Password management

Passwords can be managed.

[3] Location info

The location information that was set at the first log in is displayed.

[4] Site name

The site name that was set at the first log in is displayed.

● Version information (Non-editable)

[5] Software

[6] Firmware

When contacting us, please check the version information

● Access information (Non-editable)

[7] Number to log in (max. 4,294,967,295 times)

Indicates the total number of times someone has logged in to the sensor.

[8] Previous log in : The date of the last log in is displayed.

YYYY/MM/DD

Nickname : User information of the user who last logged in is displayed.

Belongs : User information of the user who last logged in is displayed.

[9] Last update : The date of the last update of the settings is displayed.

YYYY/MM/DD

Nickname : User information of the user who last

updated the settings is displayed.

Belongs : User information of the user who last updated the settings is

displayed.

● Operation information (Non-editable)

[10] Operating duration

Total duration from operation start is displayed.

[11] Total number of times for detection(max. 4,294,967,295 times)

The total number of detections made since operation started is displayed.

* Operation information returns to 0 when the power is turned off, or when the settings are reset to their factory defaults.

When the number reaches the maximum, it stops there

9 Troubleshooting

Symptom	Cause	Action
Operation indicator does not turn On.	Power may not be supplied.	Connect to a 12–24VAC/DC power supply.
	The supply voltage may not be correct.	Connect to a 12–24VAC/DC power supply.
Sensor detection is not correctly conveyed to a system device.	The relay output wiring is incorrect.	Wire the relay output correctly.
	Output contact type is incorrect.	Select the correct output contact type for the system device.
The operation indicator blinks in red and yellow alternately during calibration (unstable error).	There is some movement while the calibration in progress.	Remove the pedestrian or object (e.g. flag, banner, weeds) from the detection area and perform calibration again.
	A person or an object in the detection area is detected.	The ground in the detection area is uneven, such as grating. Step back people or remove objects in the detection area. If the object cannot be removed, shorten the detection range.
The operation indicator blinks in red and blue alternately during calibration (high reflection error).	The height of the unit is too low and the ground is being detected.	Install the sensor so that the bottom of the main unit is 500mm(5in.) above the ground. If the pole is tilted against the ground, the sensor may not operate properly. Please install the sensor on a pole standing up straight.
	The ground is detected because the pole on which the sensor is installed or the ground is tilted.	Adjust the sensor's angle so that it is not affected by nearby vehicles, walls (fences), or barrier arms.
	The angle of the sensor (detection area) is not correct.	Adjust the sensor's angle (detection area) 15 degree away from the gate.
	There is slide gate or swing gate in the detection area.	Connect to a 12–24VAC/DC power supply.
		Perform calibration correctly.
A vehicle entering the detection area is occasionally not detected or never detected.	Power may not be supplied.	Connect to a 12–24VAC/DC power supply.
	The supply voltage may not be correct.	Connect to a 12–24VAC/DC power supply.
	Calibration is not properly performed.	Perform calibration correctly.
	The angle of the sensor (detection area) is not correct.	Adjust the sensor's angle (detection area) to face the correct angle.
	The sensor may be affected by the background.	Perform calibration again.
	The detection range may be too short.	Increase the detection range.
	Main or Close range sensitivity is too low.	Increase Main or Close range sensitivity.
	Relay response time is too long.	Shorter Relay response time.
		Reduce Fine tuning presence.
		Remove these objects from the detection area. If they cannot be removed, reduce the detection range.
The sensor does not revert back to non-detection status when a vehicle leaves the detection area, or takes long to change status.	There is an object attached to the sensor surface such as chewing gum.	Remove the object.
	Calibration is not properly performed.	Perform calibration properly.
	The angle of the sensor (detection area) is not correct.	Adjust the sensor's angle (detection area) to face the correct angle.
	Installation location and settings of the sensor are incorrect.	Select the "Application" according to the installation location, and adjust the
	Hold timer is too long.	Set Hold timer shorter.
		Increase Fine tuning presence.
		Increase the detection range.
A vehicle was detected, but it changed to non-detection.	The angle of the sensor (detection area) is not correct.	Adjust the sensor (detection area) angle for correct detection.
	Installation location and settings of the sensor are incorrect.	Select the "Application" and "Angle" according to the installation location, and adjust the parameters.
	Hold timer is too short.	Increase Hold timer.
		Reduce Main or Close range sensitivity.
		Set Relay response time longer.
The sensor detects a pedestrian entering the detection area.	Main or Close range sensitivity is too high.	Reduce Main or Close range sensitivity.
	Relay response time is too short.	Set Relay response time longer.
	More than one pedestrian passing.	The sensor may detect a crowd. Take measures to from entering the from entering the area.

Symptom	Cause	Action
The sensor detects a pedestrian with large baggage or a metal object passing through the detection area.	Main or close range sensitivity is too high.	Reduce Main or Close range sensitivity.
	Relay response time is too short.	Increase Relay response time.
	The metal object or baggage is too large.	The sensor may not discriminate between large objects and vehicles. Take measures to prevent large groups of people from entering the area.
Sensor's response is too slow. It should detect earlier (start detecting at a further distance).	Main or Close range sensitivity is too low.	Increase Main or Close range sensitivity.
	Relay response time is too long.	Shorter Relay response time
	The detection range may be too short.	Increase the detection range.
	"Application" selection is incorrect.	Check that selected "Application" matches the installation condition.
A vehicle is not detected when re-backing up into the detection area.	Main or Close range sensitivity is too low.	Increase Main or Close range sensitivity.
	Sensitivity boost timer is disabled.	EnableSensitivity boost timer
	Sensitivity boost timer is set too short.	Set Sensitivity boost timer longer.
A vehicle in the opposite lane is detected. (Application : Barrier Protection / Activation)	Main or Close range sensitivity is too high.	Reduce Main or Close range sensitivity.
	The detection range is too long.	At the front edge of the detection area, a vehicle in the opposite lane may be detected. Adjust the detection range so that the front edge of the detection area does not reach the opposite lane.
	The angle of the sensor (detection area) is not correct.	Adjust the angle (detection area) of the sensor to be parallel to the barrier arm.
	A vehicle in the opposite lane is approaching slowly.	A vehicle approaching slowly in the opposite lane is likely to be detected.
The barrier arm is detected. The barrier arm repeatedly opens and closes. (Application : Barrier Protection)	Main or Close range sensitivity is too high.	Reduce Main or Close range sensitivity.
	The detection range is too long.	Reduce the detection range.
	Installation position of the sensor is too close to the barrier arm.	Install the sensor 300mm (12in.) away from the barrier arm.
	The angle of the sensor (detection area) is not correct.	Adjust the angle (detection area) of the sensor to be parallel to the barrier arm.
	The barrier arm has a curtain attached.	Remove the curtain.

If you still can't solve the problem even after following the instructions above, contact our technical support or sales representative or sales office. Please contact your dealer for the warranty period.

10 Specifications

10-1 Specifications

Name		Vehicle Detection Sensor (Surface mount)	
Model		OVS-02GT	
Detection method		Microwave (FMCW)	
Frequency		Microwave : 24GHz, BLE communication : 2.4GH z	
Response		MIN 500ms	
Supply voltage		12 to 24VAC/DC	
Power consumption		Heater enabled : Up to 300mA, Heater disabled : Up to 90mA(at 24V)	
Output	Spec	1	Non-voltage solid state relay output 30VDC 0.3A or less (resistance load) (N.O. / N.C.)
		2	Non-voltage mechanical relay output 30VDC 1A or less (resistance load) (N.O. / N.C.)
	Delay [s]	Off / 0.5 / 1 / 2 / 3 / 4	
	Hold timer [s]	Off / 0.5 / 1 / 2 / 3 / 10 / 30 / 60	
	Mode	Detection / Pre-detection / Mask	
Input	Type	Holding / Pulse IN / Pulse OUT	
	Pulse time duration	150ms / 250ms / 500ms / 1s	
	Spec	N.O. contact Non-voltage relay Input On resistance 100Ω or less, Off resistance 200kΩ or more, Internal pull-up voltage: approx. 3.3V	
		Mode	Link(OR gate) / Link (AND gate) / Inhibit / Wake
	Application	Barrier-Activation,Protection / Slide gate-Activation,Protection / Swing gate-Activation,Protection, Shadow	
Device setting	Detectable vehicle speed		2 to 35km/h (1.2 to 22 mi/h)
	Detection range		1.5m(7ft.) to 8.0m(26ft.) *0.5m(20in.) pitch
	Main sensitivity		Level 1 to 7
	Fine tuning_presence		Level 1 to 7
	Close range sensitivity		Level 1 to 7
	Side approach detection		Off / On(2,5s)
	Vibration sensitivity		Off / Low / Middle / High
	Sensitivity boost		Off / Low / Middle / High
	Sensitivity boost timer [s]		Off / 0.5 / 1 / 2 / 3 / 4 / 5 / 10 / 20 / 40
	Relay Response time		Level 1 to 4
	Presence detection timer [min]		5 / 15 / 60 / 180 / Infinity
	Slide gate cancellation		Off / On
Indicator	On / Off		Switchable (with the smartphone App or by holding a magnet close to the unit) Standby : Solid green, Detected : Solid red, Bad environment : Solid purple, Calibration uncompleted : Solid blue
	Standard operation mode	Detection operation	Wake up : Solid blue for 3 seconds
		Wake up	Completed reset : Blinking blue (Fast) for 2 seconds
	Smartphone app connection mode	Sensor reset	Stanby : Blinking green(slow), Detected : Blinking yellow(slow), Bad environment : Blinking purple(slow), Calibration uncompleted : Blinking blue(slow)
		Setting	Stanby : Blinking green(slow), Pre-detected : Blinking yellow(slow), Detected : Blinking red(slow)
		Detection operation	In process : Blinking Blue & Green, Error Unstable : Blinking Red & Yellow(Fast), Error High reflection : Blinking Red & Blue(Fast), High reflection : Blinking Purple(for 10s)
		Area check	
	Calibration		
Ambient Temperature		-30 to 50°C (-22 to 122 °F)	
Operating Ambient Humidity		95% max. (no condensation)	
Degree of Protection		IP66 / NEMA4	
Installation Location		Indoor / Outdoor	
Installation Height		500mm(20in.) (from the ground to the bottom of the unit)	
Sensor Angle Adjustment		Left and right : ±96°(3°pitch)	
Weight		600g (21oz) (Including accessories)	
Accessories		4pcs attached screws (2pcs Metric coarse thread M4x12, 2pcs Tapping screw 4x20), Quick reference guide	

<Notice>

Please note that we are not responsible for any damage that occurred when the equipment is operated or installed improperly.

Specifications are subject to change without notice for improvement.

10-2 Detection Area Diagram

Top view

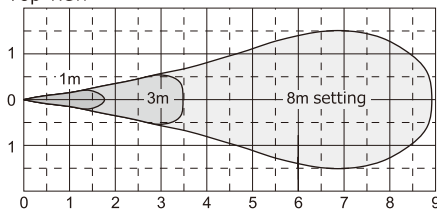

Side view

[Unit: m (1m ≈ 3.3ft.)]

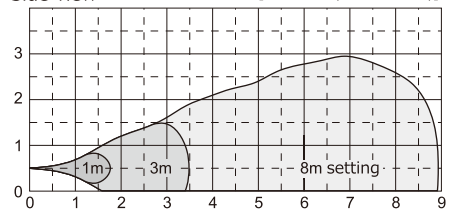

Installation height 0.5m(20"), Sensitivity: 4, Detection area check mode

* Under normal operation, the detection area by an actual vehicle may be smaller.

10-3 Dimensions

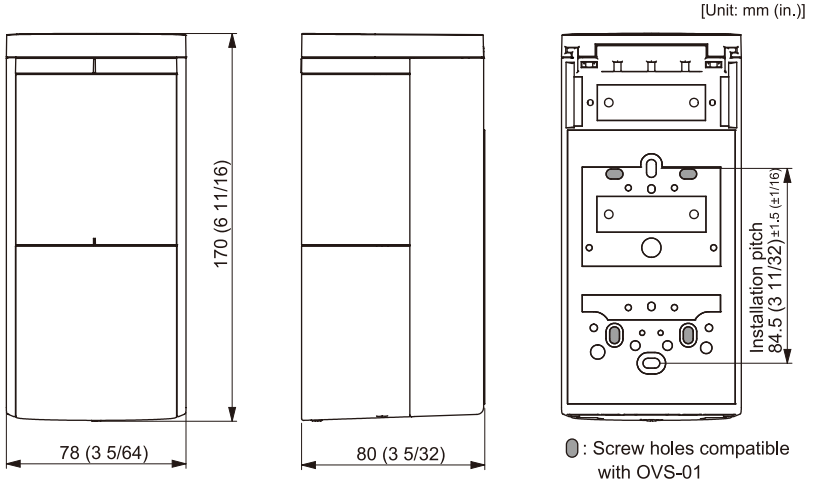

10-4 Options

- OVS-MP

Mini post for OVS series (**US only**)
 OVS-MPB: Black
 OVS-MPY: Yellow
 OVS-MPBCURB: Black for curb
 OVS-MPYCURB: Yellow for curb

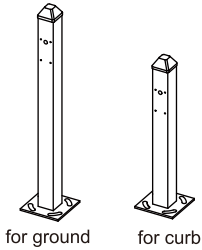

- Top/Bottom Angle Adjustment Plate (3 °)

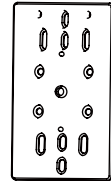

Up to three can be stacked in use.

Hereby, OPTEX declares that the radio equipment type OVS-01GT is in compliance with RED 2014/53/EU. The full text of the EU DoC is available at the following internet address: www.optex.net

EU contact information

Manufacturer: OPTEX CO., LTD. 5-8-12 Ogoto, Otsu, Shiga, 520-0101 JAPAN
Authorised representative in Europe: OPTEX (EUROPE) LTD. / EMEA HEADQUARTERS
Unit 13, Cordwallis Park, Clivemont Road, Maidenhead, Berkshire, SL6 7BU, U K
Microwave emission Frequency and Power: 24.05 - 24.25 GHz 30mW e.i.r.p

FCC NOTICE

This device complies with part 15 of the FCC Rules. Operation is subject to the following two conditions:

(1) This device may not cause harmful interference, and (2) this device must accept any interference received, including interference that may cause undesired operation.

FCC WARNING(For USA)

Changes or modifications not expressly approved by the party responsible for compliance could void the user's authority to operate the equipment.

-NOTICE-

This equipment has been tested and found to comply with the limits for a Class B digital device, pursuant to part 15 of the FCC Rules. These limits are designed to provide reasonable protection against harmful interference in a residential installation. This equipment generates, uses and can radiate radio frequency energy and, if not installed and used in accordance with the instructions, may cause harmful interference to radio communications. However, there is no guarantee that interference will not occur in a particular installation. If this equipment does cause harmful interference to radio or television reception, which can be determined by turning the equipment off and on, the user is encouraged to try to correct the interference by one or more of the following measures:

-Reorient or relocate the receiving antenna.

-Increase the separation between the equipment and receiver.

-Connect the equipment into an outlet on a circuit different from that to which the receiver is connected.

-Consult the dealer or an experienced radio/TV technician for help.

-NOTICE-

1. The antennas cannot be exchanged.

2. To comply with FCC RF exposure compliance requirements, a separation distance of at least 20cm must be maintained between the antenna of this device and all persons.

-ISED NOTICE-

This device contains licence-exempt transmitter(s)/receiver(s) that comply with Innovation, Science and Economic Development Canada's licence-exempt RSS(s). Operation is subject to the following two conditions:

1. This device may not cause interference.

2. This device must accept any interference, including interference that may cause undesired operation of the device.

This equipment complies with ISED radiation exposure limits set forth for an uncontrolled environment and meets RSS-102 of the ISED radio frequency (RF) Exposure rules. This equipment should be installed and operated keeping the radiator at least 20cm or more away from person's body.

L'émetteur/récepteur exempt de licence contenu dans le présent appareil est conforme aux CNR d'Innovation, Sciences et Développement économique Canada applicables aux appareils radio exempts de licence.

L'exploitation est autorisée aux deux conditions suivantes :

1. L'appareil ne doit pas produire de brouillage;

2. L'appareil doit accepter tout brouillage radioélectrique subi, même si le brouillage est susceptible d'en compromettre le fonctionnement.

Cet équipement est conforme aux limites d'exposition aux rayonnements énoncées pour un environnement non contrôlé et respecte les règles d'exposition aux fréquences radioélectriques (RF) CNR-102 de l'ISDE. Cet équipement doit être installé et utilisé en gardant une distance de 20 cm ou plus entre le radiateur et le corps humain.



OPTEX CO.,LTD. (JAPAN)

(ISO 9001 Certified) (ISO 14001 Certified)

5-8-12 Ogoto Otsu Shiga 520-0101 JAPAN

TEL:+81-77-579-8670 www.optex.net

OPTEX (EUROPE)LTD. (UK)

TEL:+44-1628-631000 www.optex-europe.com

OPTEX SECURITY SAS (FRANCE)

TEL:+33-437-55-50-50 www.optex-security.com

OPTEX INC. (USA)

TEL:800-877-6656 (Toll free) www.optex-vs.com

OPTEX SECURITY Sp.zo.o. (POLAND)

TEL:+48-22-598-06-55 www.optex.com.pl

OPTEX KOREA CO., LTD. (KOREA)

TEL:+82-2-719-5971 www.optexkorea.com

OPTEX (DONGGUAN) CO., LTD.

SHANGHAI OFFICE (CHINA)

TEL:+86-21-34600673 www.optexchina.com