

VIDEOKIT ESVK/6388 SERIES

"2 Wire" bus one way, two way videokit

ESVK
ESVKX
ESVKC

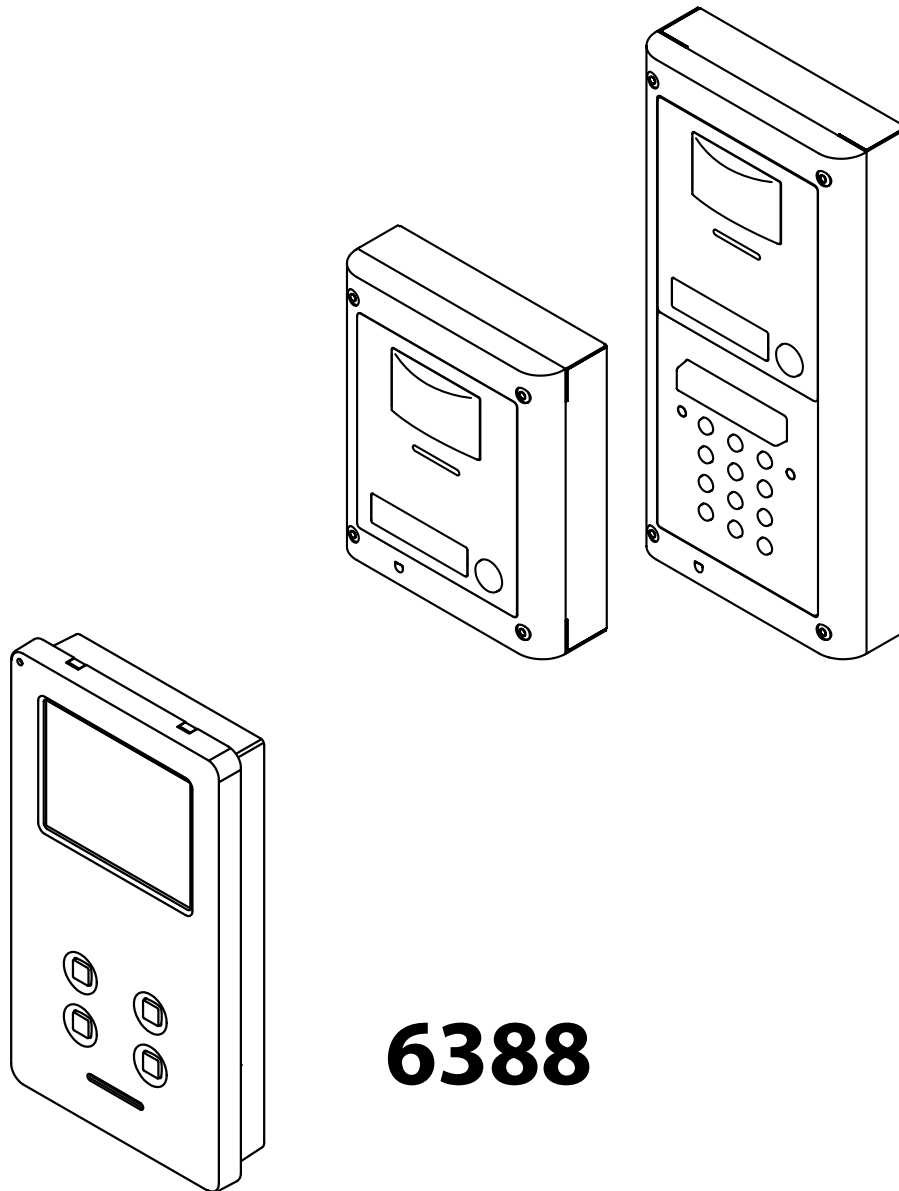

Installation handbook

Index

System components and available versions	3
General directions for installation	6
Art. 4333/4333X Speaker unit module with built-in functional to digital interface.....	8
Art. 4800 - 4800M Digital codelock module.....	13
4000 Series surface and flush mounting door station installation	16
Art. 6388 3.5" colour display videophone	18
6300 Series Videophone wall mounting instructions	22
Art. 2321-2321/P Power supplies for VX2300	23
Art. 2322 Power supply converter from BUS line to 12 Vdc	24
Art. 125 Call expansion module	25
Installation diagrams	77

NOTES AND SUGGESTIONS

- All diagrams refer to all kits versions: flush or surface, colour or black & white.
- Dashed connections refer to optional connections ("Local bell", "Push to exit" & "Door monitor").
- Some diagrams show how to connect a 12Vdc electric lock: these directions are suitable for all diagrams in this manual.
- Each time a setting is changed on a videophone (address, extension, number of rings etc.), the videophone must be disconnected from the relevant connection board then after a few seconds reconnected again to allow the recognizing of the new setting.
- All diagrams shown are valid for B&W or colour systems with surface or flush mount door station.

ADDRESSES 1..12 TABLE FOR DIP-SWITCH BANKS WITH ON POSITION UP

 = OFF

 = ON



DECLARATION OF RESPONSIBILITY

This manual has been written and revised carefully. The instructions and the descriptions which are included in it are referring to VIDEX parts and are correct at the time of print. However, subsequent VIDEX parts and manuals, can be subject to changes without notice. VIDEX Electronics S.p.A. cannot be held responsible for damages caused directly or indirectly by errors, omissions or discrepancies between the VIDEX parts and the Manual.



WE RECOMMEND

This equipment is installed by a Competent Electrician, Security on Communications Engineer

System components and available versions

ESVK/6388 Colour videokit.

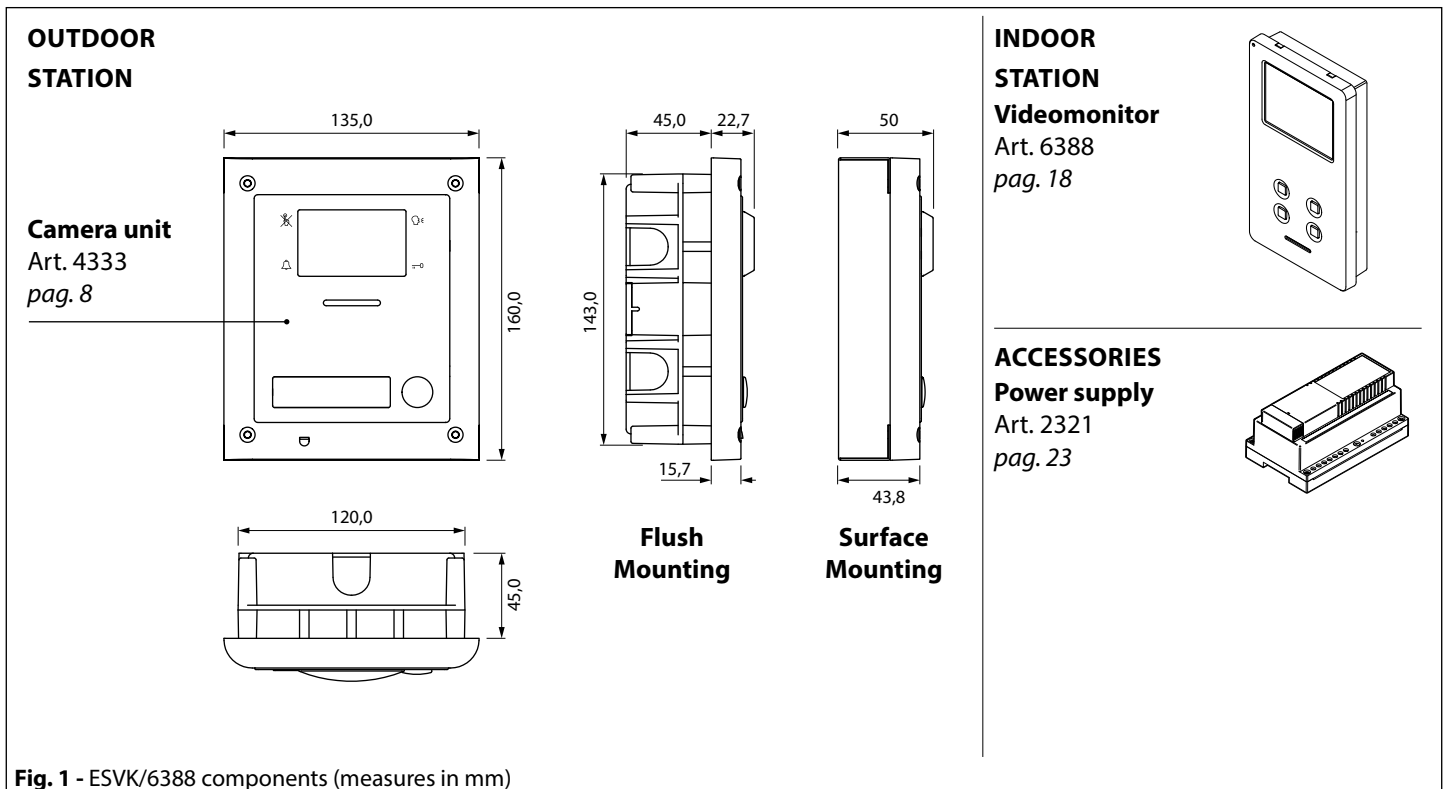



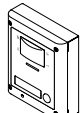





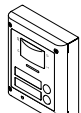





Fig. 1 - ESVK/6388 components (measures in mm)

ONE WAY VERSIONS	ESVK-1/6388 - flush mounting  1 Outdoor station composed of: 1 Art. 4333-1: 1 button camera unit 1 Art. 4851: Flush mounting box	 1 Colour videomonitor Art. 6388	 1 Power supply Art. 2321
	ESVK-1S/6388 - surface mounting  1 Outdoor station composed of: 1 Art. 4333-1: 1 button camera unit 1 Art. 4881: Surface mounting box	 1 Colour videomonitor Art. 6388	 1 Power supply Art. 2321
TWO WAY VERSIONS	ESVK-2/6388 - flush mounting  1 Outdoor station composed of: 1 Art. 4333-2: 2 buttons camera unit 1 Art. 4851: Flush mounting box	  2 Colour videomonitors Art. 6388	 1 Power supply Art. 2321
	ESVK-2S/6388 - surface mounting  1 Outdoor station composed of: 1 Art. 4333-2: 2 buttons camera unit 1 Art. 4881: Surface mounting box	  2 Colour videomonitors Art. 6388	 1 Power supply Art. 2321

ESVKX/6388 Colour videokit with embended proximity key reader.

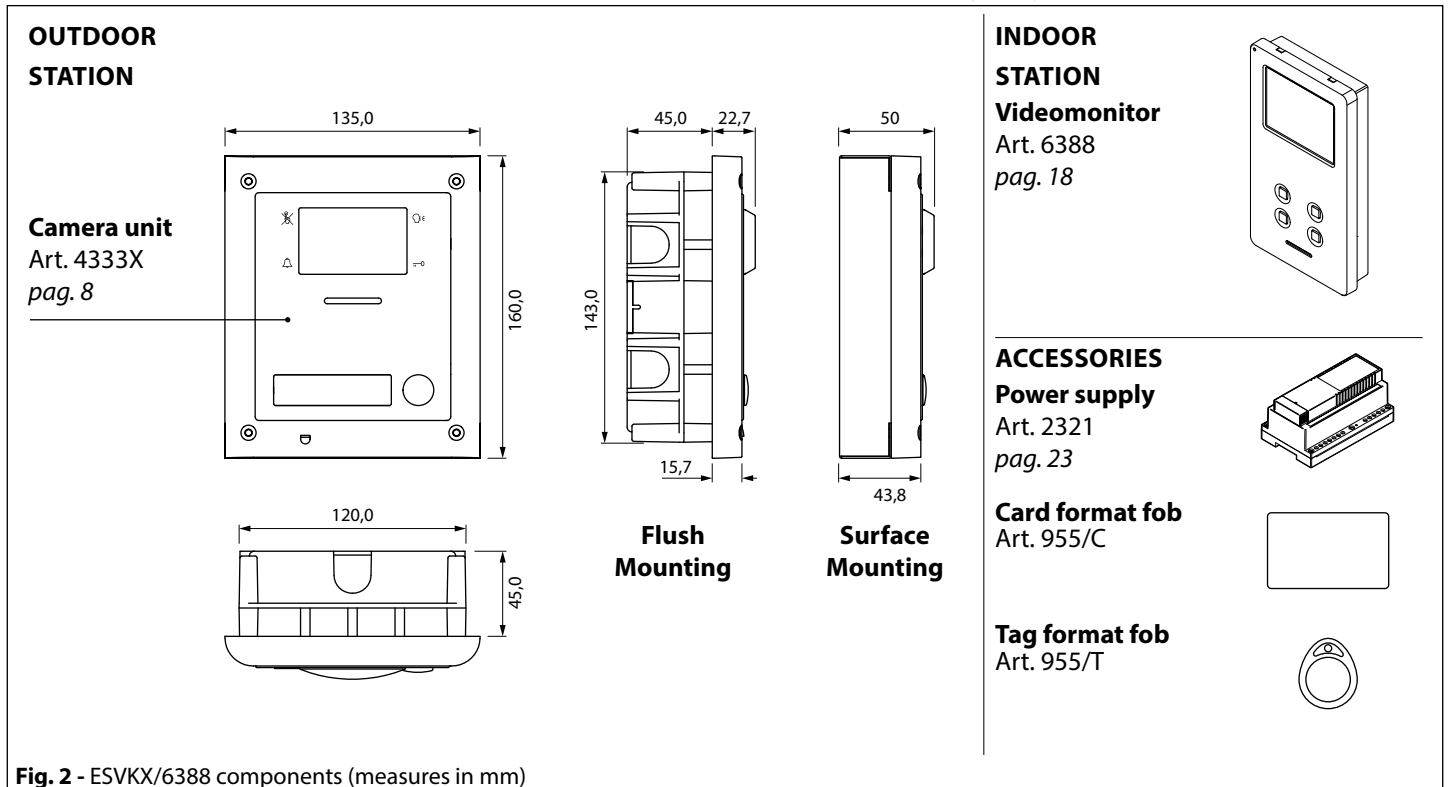





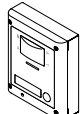







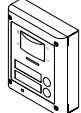







Fig. 2 - ESVKX/6388 components (measures in mm)

ONE WAY VERSIONS	ESVKX-1/6388 - flush mounting	 1 Outdoor station composed of: 1 Art. 4333X-1: 1 button camera unit 1 Art. 4851: Flush mounting box	 1 Colour videomonitor Art. 6388	 1 Power supply Art. 2321  1 Card format fob Art. 955/C  2 Tag format fobs Art. 955/T
	ESVKX-1S/6388 - surface mounting	 1 Outdoor station composed of: 1 Art. 4333X-1: 1 button camera unit 1 Art. 4881: Surface mounting box	 1 Colour videomonitor Art. 6388	 1 Power supply Art. 2321  1 Card format fob Art. 955/C  2 Tag format fobs Art. 955/T
	TWO WAY VERSIONS	ESVKX-2/6388 - flush mounting	 1 Outdoor station composed of: 1 Art. 4333X-2: 2 buttons camera unit 1 Art. 4851: Flush mounting box	  2 Colour videomonitors Art. 6388
ESVKX-2S/6388 - surface mounting		 1 Outdoor station composed of: 1 Art. 4333X-2: 2 buttons camera unit 1 Art. 4881: Surface mounting box	  2 Colour videomonitors Art. 6388	 1 Power supply Art. 2321  1 Card format fob Art. 955/C  4 Tag format fobs Art. 955/T

ESVKC/6388 Colour videokit plus a codelock module.

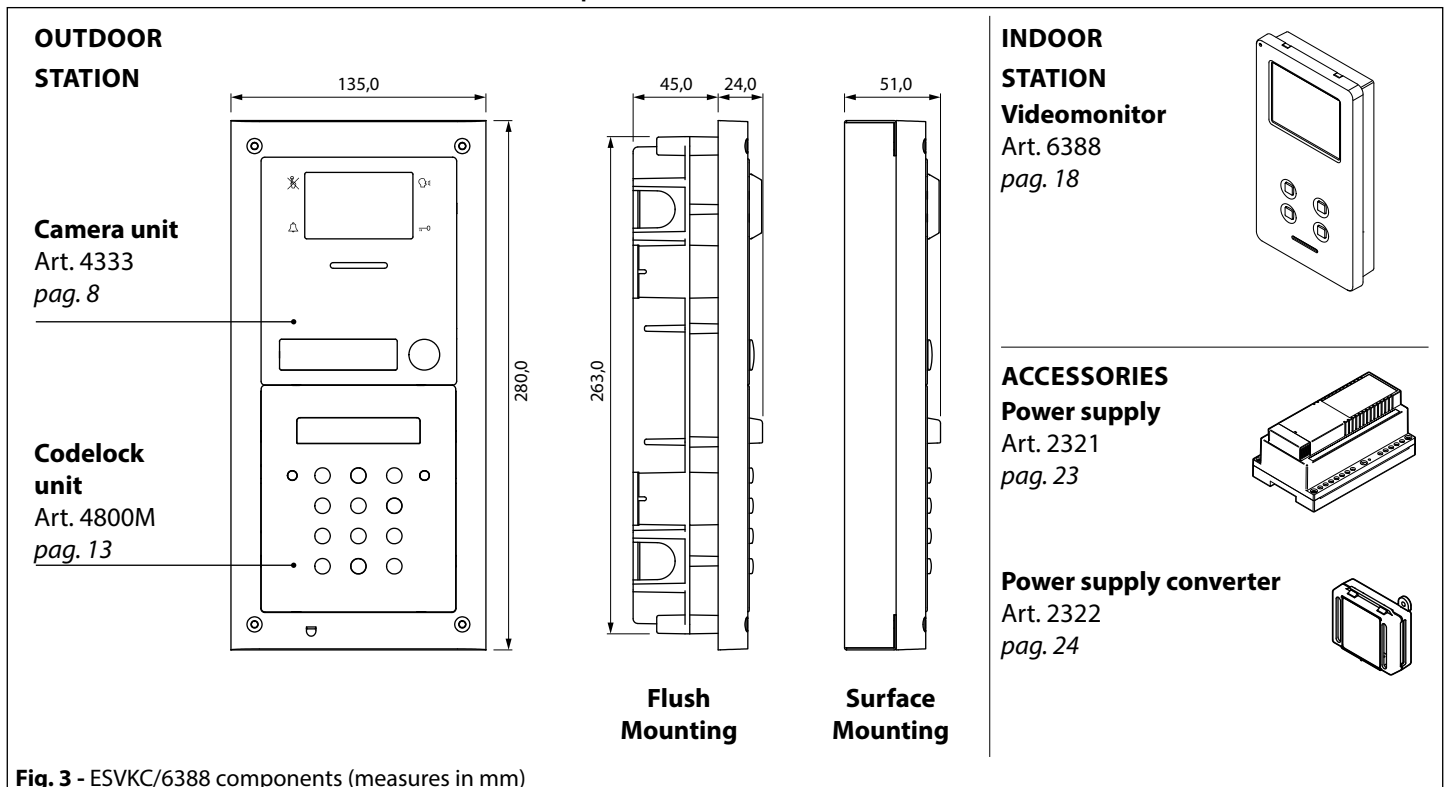
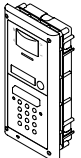
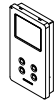

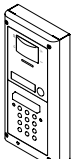
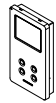

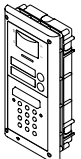
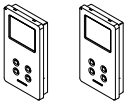

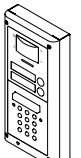
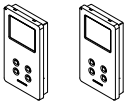



Fig. 3 - ESVKC/6388 components (measures in mm)

ONE WAY VERSIONS	
<p>ESVKC-1/6388 - flush mounting</p>  <p>1 Outdoor station composed of: 1 Art. 4333-1: 1 button camera unit 1 Art. 4800M: Codelock module 1 Art. 4852: Flush mounting box</p>	 <p>1 Colour videomonitor Art. 6388</p>  <p>1 Power supply Art. 2321</p>  <p>1 Power supply converter Art. 2322</p>
<p>ESVKC-1S/6388 - surface mounting</p>  <p>1 Outdoor station composed of: 1 Art. 4333-1: 1 button camera unit 1 Art. 4800M: Codelock module 1 Art. 4882: Surface mounting box</p>	 <p>1 Colour videomonitor Art. 6388</p>  <p>1 Power supply Art. 2321</p>  <p>1 Power supply converter Art. 2322</p>
TWO WAY VERSIONS	
<p>ESVKC-2/6388 - flush mounting</p>  <p>1 Outdoor station composed of: 1 Art. 4333-2: 2 buttons camera unit 1 Art. 4800M: Codelock module 1 Art. 4852: Flush mounting box</p>	 <p>2 Colour videomonitors Art. 6388</p>  <p>1 Power supply Art. 2321</p>  <p>1 Power supply converter Art. 2322</p>
<p>ESVKC-2S/6388 - surface mounting</p>  <p>1 Outdoor station composed of: 1 Art. 4333-2: 2 buttons camera unit 1 Art. 4800M: Codelock module 1 Art. 4882: Surface mounting box</p>	 <p>2 Colour videomonitors Art. 6388</p>  <p>1 Power supply Art. 2321</p>  <p>1 Power supply converter Art. 2322</p>

General directions for installation

CABLE TYPES AND CROSS SECTIONAL AREAS

The VX2300 digital system can use several types of cables but depending on their specification will allow different distances up to 400 meters maximum. We do not recommend the use of shielded cables because of the high eddy capacitance. It is also not advised to double up on cables as this will also increase the capacitance. The following table specifies values of resistance, capacitance and maximum distances achievable for several types of cables (capacitance and resistance values are referring to 100 metres of cable).

Cable Type**	Wires Section (mm ²)	Resistance (Ohm) per 100 metres	Capacitance (nF) per 100 metres	*Maximum Distance (metres)
VIDEX CM2	0.50	3.2	8	200m
CAT5 UTP/CW1308	0.22	8	4.9	70m
Std Telephone Cable	0.28	6.5	5.5	100m
Standard wire	0.8 / 1	2	6.5	70m

* **The maximum distance represents the maximum distance from power supply. i.e. the cable length between the outdoor station and the power supply or between the power supply and the videophone.**

There are two important characteristics to consider when calculating cable, the resistance and the capacitance. The resistance of the cable from power supply to end point must be less than 10 Ohms and can be calculated from point to point. The capacitance of the cable must not exceed 40nF and is an accumulation of all lengths and branches of the cable. For example: Videx CM2 cable can be used for a maximum distance of 200m from door station to power supply and another 200m from power supply to videophone (400 meters) but this distance may be reduced if the maximum capacitance is reached first.

When using the block exchanger art. 2306 it is possible to exceed the limit of 400m. The 2306 breaks the system into smaller systems or blocks, each block can then achieve the 400m.

For example: in a system with two block exchangers:

- Using 100m to reach the first block, you can then use up to 300m cable in the block;
- Assuming you are using another 50 meters cable to get from the first to the second block, in the second you can use $(400-100-50) = 250m$.

** **It is important that the video intercom system cables do not run with mains or other high power cables. Noise from such cables (electromagnetic interference) may cause noises on audio/video and lost functionality. In cases where this advice can not be followed or when existing cables are to be used it will be necessary to carry out tests to assess the quality and functionality of the installation.**

In case of use of cables not in conformity with above specification it is possible to experience deterioration of digital and video signals. We suggest to use twisted cables with maximum resistance of 10 Ohm (between the furthest door station and the furthest videophone) and maximum capacitance of 40nF (this value must be calculated considering all the cables used in the system; the capacitance/metres value is normally specified on the cable package or directly on the cable).

BUS DEVICE SETUP AND VIDEO DISTRIBUTION

- When changing dip switch settings, disconnect the device from the bus for a minimum of 1 minute to allow the unit to fully discharge.
- When you have more than one device in the same apartment, all the devices must be connected to the same video distributor (Art. 317N): this means that you cannot use two video distributors Art. 318 for one apartment where you have 3 or 4 videophones/intercoms.
- After completing the installation proceed to testing. The video level gain can be adjusted at several points including distributors, entrance exchanger and bus boosters.

HOW TO CONNECT A LOCAL POWER SUPPLY

The drawing below shows how to connect a local power supply when required (i.e. when you have 4 videophones with the same address that must be switched on at the same time). In both cases switch 4 of SW3 must be set to the ON position.

NOTE! OBSERVE CONNECTION POLARITIES AS SHOWN IN THE DIAGRAM BELOW.

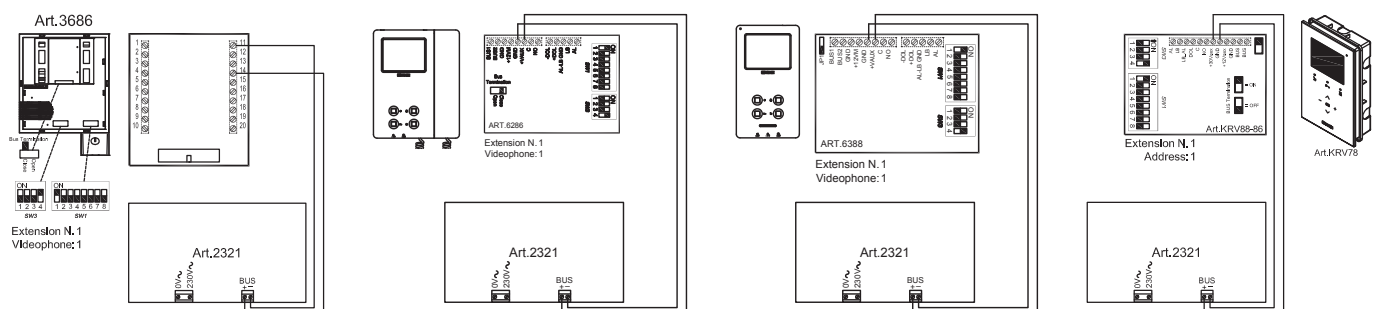

CABLES LENGTH

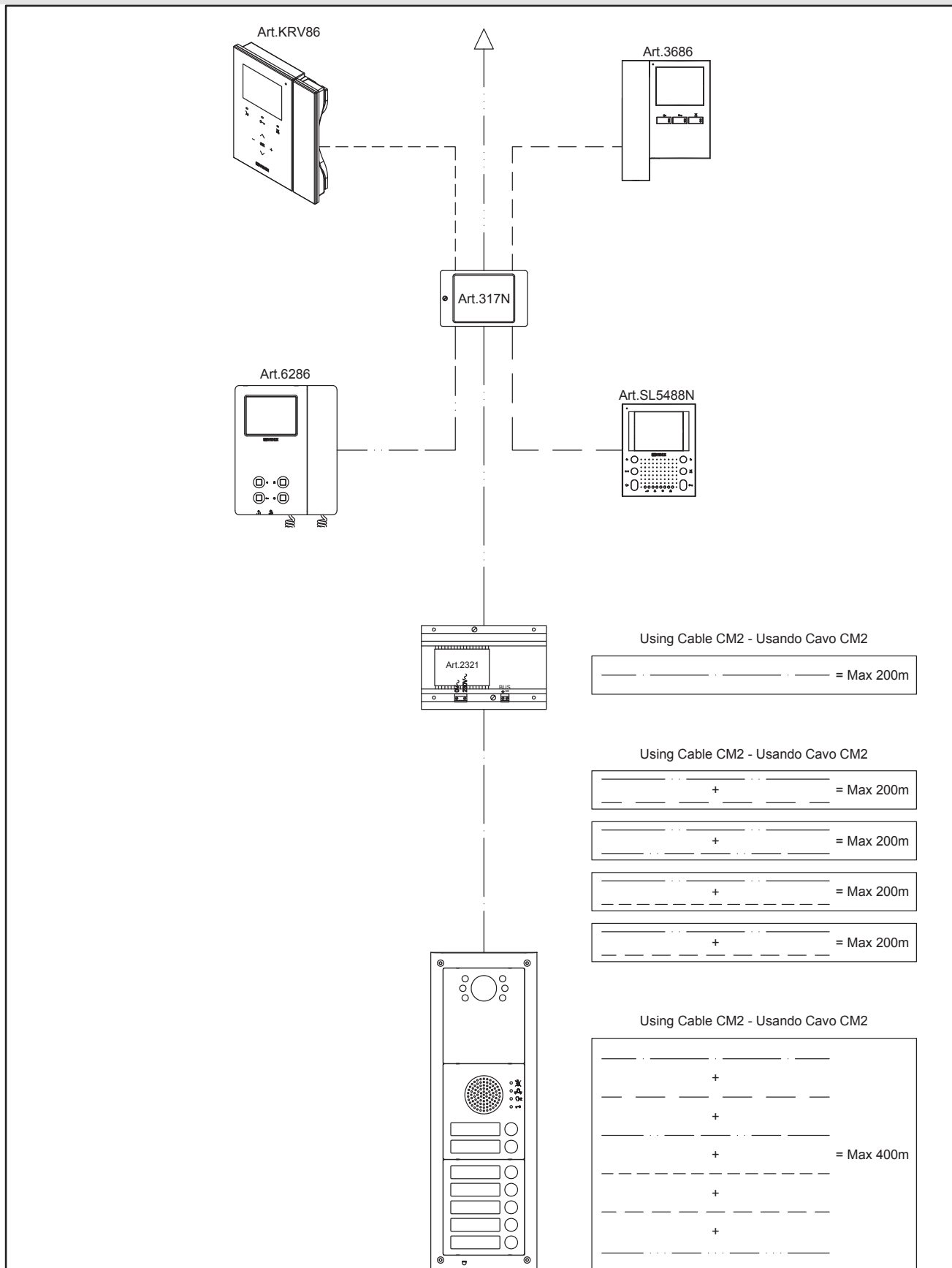

Title:		Data creazione:	02/07/2014	Foglio	1 / 1
Titolo:		Data modifica:	02/07/2014		
		Autore:	Marco Rongoni		
		Cod. File:	VX2300CL.dwg		

Videx Electronics S.p.A.
 Via del Lavoro 1, 63846 Monte Giberto (FM)
 Phone: +39 0734 631669 - Fax +39 0734 631669

Notes:

 Note:

Art. 4333/4333X

Speaker unit module with built-in functional to digital interface

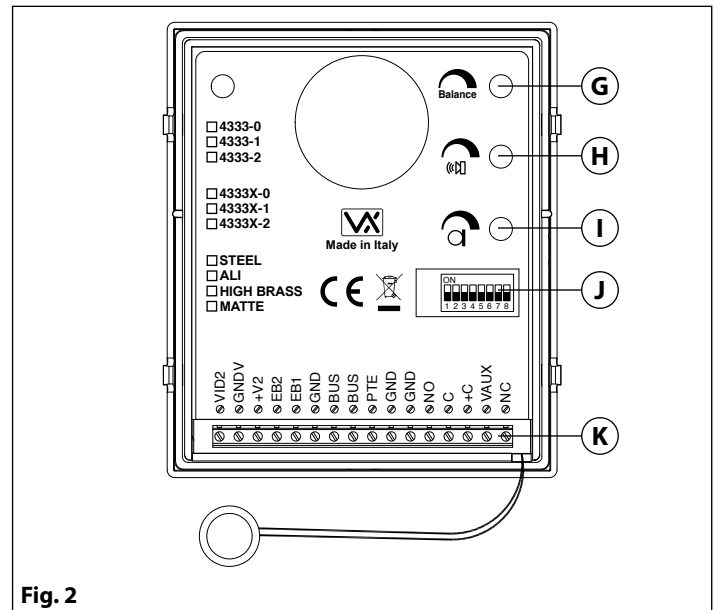
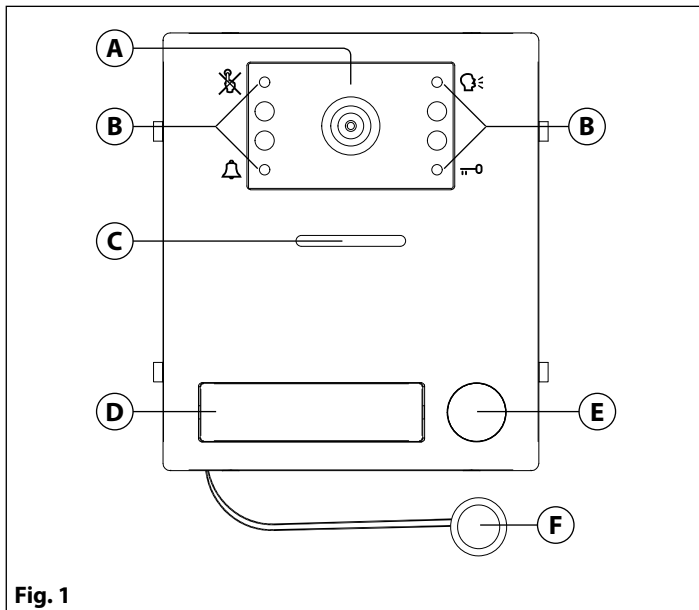

DESCRIPTION

Speaker unit module with built-in colour camera with autoiris lens and white light illumination LEDs. Depending on the speaker unit version it includes one or two call push buttons. The unit circuitry incorporates:

- An embedded proximity key reader (Art. 4333X only);
- The transmitting amplifier with microphone and volume control;
- The receiving amplifier with volume control;
- The audio balance circuit with "BALANCE" control;
- The enslavement relay to enable the electric lock (3 contacts: common, normally open and normally closed). It can work also as capacitor discharge to supply directly the electric lock;
- The call buttons from 1 to a maximum of 2 depending on the module version;
- The illumination LEDs for the card name holder;
- The camera comprised of illumination LEDs.

MODULE DETAILS:

- Ⓐ Camera with illumination LEDs;
- Ⓑ Operation LEDs;
- Ⓒ Loudspeaker;
- Ⓓ Card name holder with built-in proximity reader;
- Ⓔ Call push button (0, 1 or 2 depending on the model);
- Ⓕ Microphone;
- Ⓖ Balance Control;
- Ⓗ Loudspeaker volume control;
- Ⓘ Microphone volume control;
- Ⓝ Dip-switch to carry out the following programming:
 - Door station ID (switches from 1 to 3);
 - Door opening time (switch 4 and 5);
 - Conversation time (switch 6);
 - Address order (switch 7);
 - Main camera selection (switch 8);
- Ⓚ System connection terminals.

AVAILABLE MODULE VERSIONS

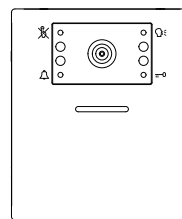

Art. 4333-0

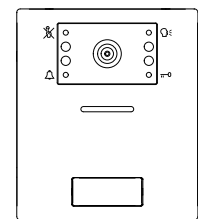



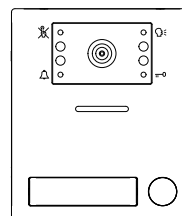

Art. 4333X-0

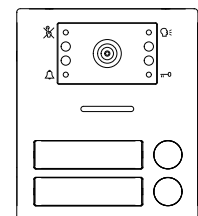

Art. 4333-1
Art. 4333X-1



Art. 4333-2
Art. 4333X-2

FRONT LEDS SIGNALLING DESCRIPTION	
	When illuminated, indicates that it is not possible to make a call because a call or a conversation is in progress (from the outdoor station from which you are calling or from another outdoor station on systems with multiple entrances). The LED will be off when the system is in stand-by,
	If illuminated, indicates that the call from the outdoor station is in progress. The LED will switch OFF when the call is answered or after the programmed number of rings.
	If illuminated, indicates that it is possible to speak because the call has been answered. The LED will switch OFF at the end of a conversation (or at the end of the conversation time).
	If illuminated, indicates that the door lock has been operated. It will switch OFF at the end of the programmed "door opening" time.

PROGRAMMING

The programming consists of the following settings:

- Unit ID (1..8);
- Door Opening Time (1, 2, 5 or 10 seconds);
- Conversation Time (1 or 2 minutes);
- Addressing order of the buttons.
- Main camera selection

The settings are carried out through the 8 way dip-switch (reference J on Fig. 2) accessible from the rear side of the module.

UNIT ID			
Switches			ID
1	2	3	
OFF	OFF	OFF	1
ON	OFF	OFF	2
OFF	ON	OFF	3
ON	ON	OFF	4
OFF	OFF	ON	5
ON	OFF	ON	6
OFF	ON	ON	7
ON	ON	ON	8

DOOR OPENING TIME		
Switches		Seconds
4	5	
OFF	OFF	1
ON	OFF	2
OFF	ON	5
ON	ON	10

CONVERSATION TIME	
Switch	Minutes
6	
OFF	1
ON	2

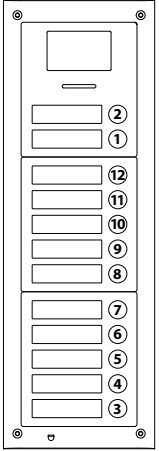
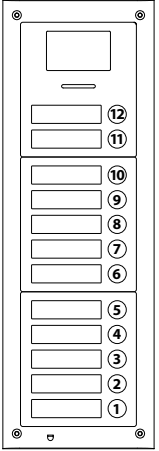
ADDRESSES ORDER			
Switch	Sort	Switch	Sort
7		7	
OFF		ON	

Art. 125 required. When Art. 125 is used, follow the directions in the diagram to supply the push buttons modules.

MAIN CAMERA SELECTION	
Switch	Selection
8	
OFF	Main camera internal
ON	Main camera external

MAXIMUM ILLUMINATION DISTANCE FROM CAMERA AT NIGHT

The illumination LED's within the camera will illuminate the visitor when they are within 50 cm of the camera.

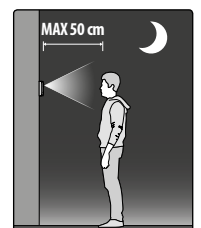

PROGRAMMING TAGS (FOR ART. 4333X)
MASTER TAG

The external module is supplied with a master tag. The master tag is programmed in-factory, it is white to easily stand out. This tag enables user tags to be programmed or cleared.

If the master tag is lost, a new one will have to be ordered and a specific procedure performed to program it on the external module. In this instance, it will be necessary to reprogram all the user tags.

USER TAG

The user tags can be programmed on the external module using the master tag to access programming mode:

1. Place the master tag in front of the tag reader.

↳ The external module emits two high-pitched "bip".



2. Press the call button (the lower call button in the case of a 2-button external module).

↳ The external module emits a low-pitched continuous "beeping" sound.



3. Release the call button.

↳ The low-pitched "beeping" sound stops.

4. Place the user tag to be programmed in front of the tag reader.

↳ The external module emits a high-pitched "beeping" sound, the tag is programmed. If you do not remove the tag quickly, may be emitted the alert for an already programmed tag.



5. Repeat the step 4 for each tag to program.

Note: the external module emits three low-pitched "beeping" sounds if an already programmed tag is placed in front of the tag reader.



Note: the external module emits three high-pitched "beeping" sounds to indicate that its memory is full (50 tags maximum). In this instance, it is not possible to program new tags.



6. To exit programming mode:

» place the master tag in front of the tag reader, or

» wait 10 seconds after the most recent programming operation.

↳ The external module emits two low-pitched "beeping" sounds in order to indicate that it is in operational mode.

USING TAGS

Place a tag in front of the tag reader:

↳ If the tag is programmed, the external module emits two high-pitched "beeping" sounds and its relay is activated.



↳ If the tag is not programmed, the external module emits three low-pitched "beeping" sounds and its relay is not activated.

CLEARING USER TAGS

⚠ The following procedure will clear the programming on all user tags.

Clearing the user tag programming is carried out on the external module using the master tag to run the procedure:

1. Place the master tag in front of the tag reader.

↳ The external module emits two high-pitched "bip".



2. Press the call button (the lower call button in the case of an external 2-button module) BIP.

↳ The external module emits a low-pitched continuous "beeping" sound.



3. Release the call button.

↳ The low-pitched "beeping" sound stops.

4. Press and hold down the call button and place the master tag in front of the tag reader.

↳ The external module emits two low-pitched "beeping" sounds, all user tags have been cleared and the external module exits programming mode.



Art. 4333/4333X Speaker unit module with built-in functional to digital interface

REPROGRAMMING A MASTER TAGS

If the master tag is lost or damaged, a new one can be programmed using the following procedure:

1. Switch off the power.
2. Open the external module housing.
3. Bridge the **PTE** and **GND** terminals or press and hold down the "press to exit" button, if this is wired to the external module (refer to the external module's instructions).
4. Switch the power back on.
↳ The external module emits a high-pitched "beeping" sound.
5. Remove the short between the **PTE** and **GND** terminals or release the "press to exit" button.
↳ The external module emits a high-pitched "beeping" sound.
6. Place the master tag in front of the tag reader.
↳ The external module emits two high-pitched "beeping" sounds, then two low-pitched "beeping" sounds, the master tag is programmed, all user tags have been deprogrammed and the external module exits programming mode.
7. Close the external module's housing.

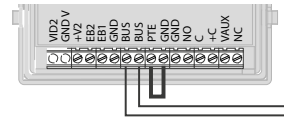

HOW TO CONNECT AN ELECTRIC LOCK

The "door-open" relay can operate either as "dry contact" or "capacitive discharge" mode.

- In "dry contact" operation mode the relay works in a traditional way, a power supply or a power source is needed to operate the lock (12-24Vac/dc 2A max), and activation lasts according to the door opening time programmed.
 - In "capacitive discharge" operation mode the relay's contacts, when active, supply directly the lock (12Vac/dc 1A max) for a moment. You don't need a power supply for the lock and the door opening time programmed does not affect the activation time.
- A possible deterioration of the mechanical performance of the electric lock, might cause the "capacitive discharge" to malfunction in time. In case the electric lock is used in very dusty environments or in peculiar climate conditions, we suggest to use the "open door" relay in "dry contact" mode.

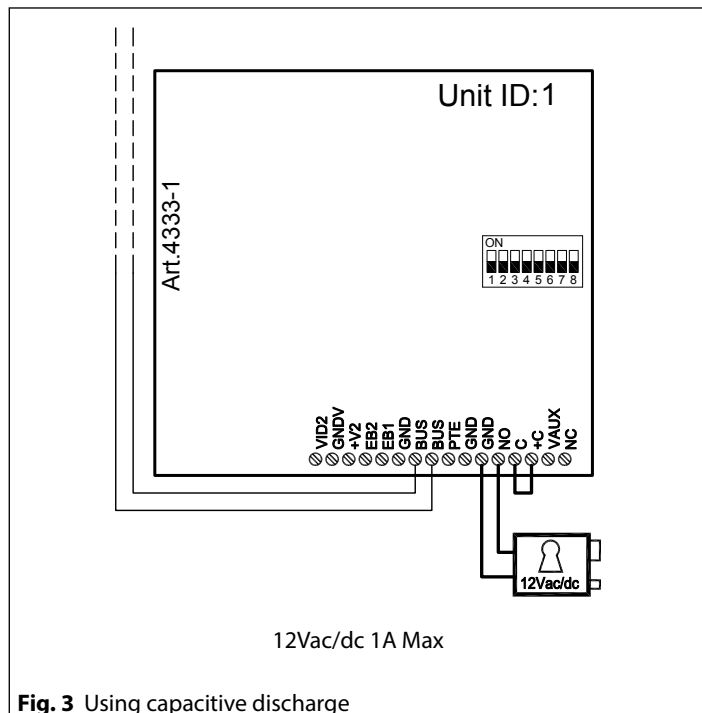

Fig. 3 Using capacitive discharge

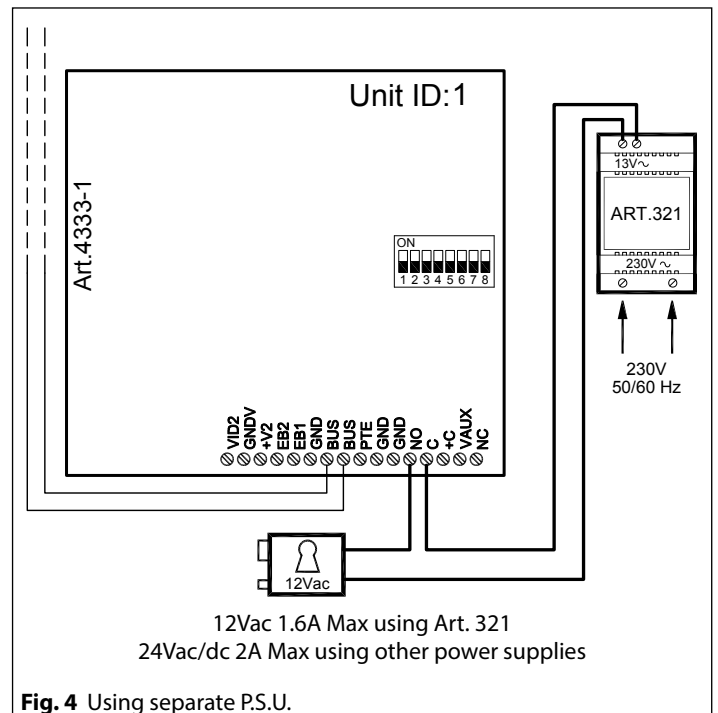

Fig. 4 Using separate P.S.U.

ADHESIVE GASKET PLACEMENT

Apply the (Y) seal as shown in **Fig. 5**.

ANTI-TAMPERING LOCKS FIXING

Fit the anti-tampering locks (W) as shown in **Fig. 6**.

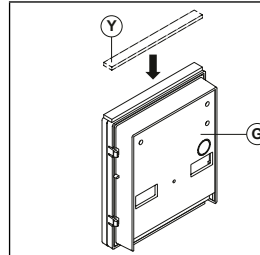

Fig. 5

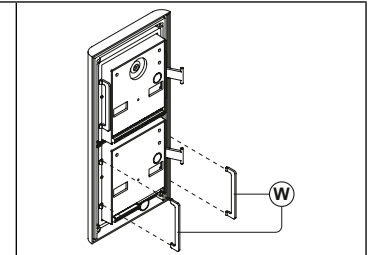

Fig. 6

HOW TO REMOVE/INSERT THE CARD NAME HOLDER

- To avoid damage to the module front plate, mask the side that will be in contact with the screwdriver blade;
- Insert the screwdriver (flat side) into the card-holder hole as shown in **Fig. 7**;
- Move the screwdriver to the left as shown in **Fig. 8** to extract the card name holder;
- Edit the card name then replace it inside the holder and refit: insert the holder inside its housing from the left or right side then push the other side until it clips into place.

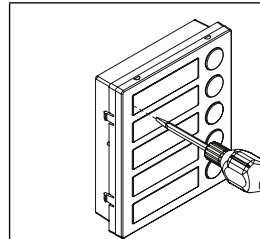

Fig. 7

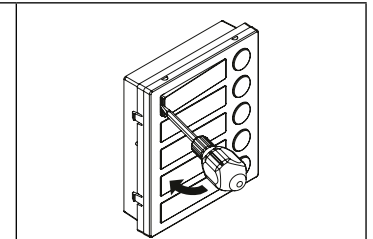

Fig. 8

SIGNALS ON SYSTEM CONNECTION TERMINALS		
VID2	Video signal input (coax centre core)	
GNDV	Video signal ground (coax screen and 0V to camera)	
+V2	Output to supply the external camera if necessary	Max 12Vdc 150mA
EB2	Expansion button input 2	
EB1	Expansion button input 1	
GND	Ground	
BUS	BUS Connection terminals	
BUS		
PTE	"Push to exit" active low input	
GND	Ground	
GND		
NO	Door open relay normally open contact	Max 12-24 Vac/dc 2A
C	Door open relay common contact	
+C	Electric lock capacitor discharge output	
VAUX	35Vdc power supply input (if used, the module is powered locally and not from the BUS)	
NC	Door open relay normally closed contact	Max 12-24 Vac/dc 2A

CLEANING OF THE PLATE

Use a clean and soft cloth. Use moderate warm water or non-aggressive cleansers.

Do not use:

- abrasive liquids;
- chlorine-based liquids;
- metal cleaning products.

UNIT SPECIFICATION

- Housing/Mounting:** One 4000 Series Module / 4000 Series Modular System
- Push Buttons:** Yes, from 0 to 2 call buttons depending on the model
- Programming:** Yes, carried out by the 8 way dip-switch located on the rear of the module
- Controls:** Microphone and Loudspeaker volume trimmers plus balance trimmer
- Power Supply:** Supplied by the BUS line
- Power consumption:** Stand-by: 50 mA
Operating: 165 mA
- Working Temperature:** -10 +50 °C

Art. 4800M Digital codelock module

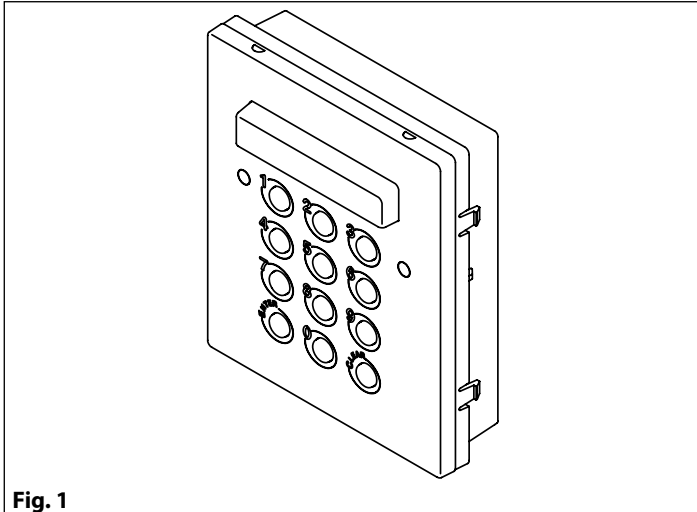

Fig. 1

DESCRIPTION

The module features 12 stainless steel buttons (Keys **0 - 9**, **ENTER** and **CLEAR**), 2 LED's for progress information during use and programming and a mirror finish stainless steel front plate (Standard version). With three integral relays each with common, normally open and normally closed connections and two inputs to enable the external triggering of relays one and two (For example, push to exit button). Key presses are signalled both acoustically and visually while each button press has a tactile feel. Entering the correct code followed by **ENTER** will activate the relevant relay. Programming is carried out through the same keypad following a simple programming menu. The module can be combined with other 4000 Series modules in an audio or video intercom system.

MAIN FEATURES

- 3 **C, NC, NO** relay outputs (24Vac/dc – 5A max);
- 3 Programmable secret codes (one for each relay);
- Each relay can be set to be activated for a specific time (01 to 99 seconds) or to work as latch;
- Two active low inputs to command directly the relay 1 and 2;
- Programming menu guarded by a 4-8 digit programmable engineer's code;
- Visual and Acoustic signal during operating and programming;
- Keypad illumination LEDs;

GENERAL DIRECTIONS FOR INSTALLATION

In order to achieve the best results from the schematics described it is necessary to install only original VIDEX equipment, strictly keeping to the items indicated on each schematic and follow these General Directions for Installation:

- The system must be installed according to national rules in force, in any case the running of cables of any intercom unit must be carried out separately from the mains;
- All multipair cables should be compliant to CW1308 specification (0.5mm twisted pair telephone cable).
- Cables for speech line and service should have a max resistance of 10 Ohm
- Lock release wires should be doubled up (Lock release wires and power supply wires should have a max resistance of 3 Ohm);
- The cable sizes above can be used for distances up to 50m. On distances above 50m the cable sizes should be increased to keep the overall resistance of the cable below the RESISTANCES indicated above;
- Double check the connections before power up;
- Power up the system then check all functions.

LOCK RELEASE BACK EMF PROTECTION

A varistor must be fitted across the terminals on AC lock release (**Fig.1A**) and a diode must be fitted across the terminals on a DC lock release (**Fig.1B**) to suppress back EMF voltages. Connect the components to the lock releases as shown in figures.

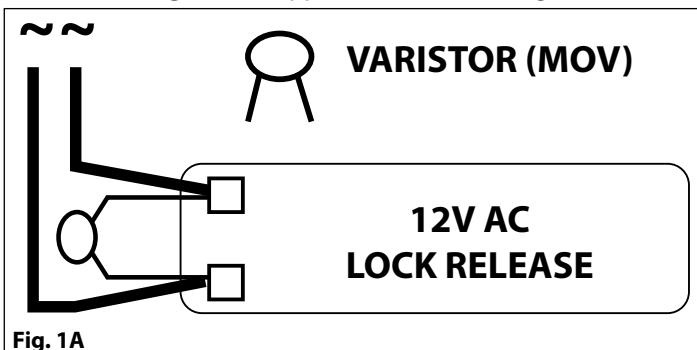

Fig. 1A

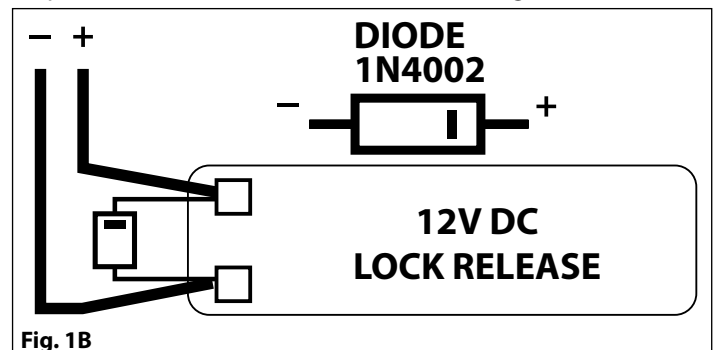

Fig. 1B

BUZZER BACK EMF

When using intercoms with buzzer call (Art.924/926, SMART1/2, 3101/2, 3001/2 and 3021/2) add one 0.1uF (100nF) capacitor between terminals 3 and 6 on the telephone.

BUILT-IN RELAYS – BACK EMF PROTECTION

The Art. 4800M includes selectable back EMF protection on the relays. The jumpers marked **MOV** (One jumper for each relay) are used to select the protection type. When using a fail secure lock with connections **C & NO** the jumper should be in the **NO** position. When using a fail open lock with connections **C & NC** the jumper should be in the **NC** position and when using the codelock to trigger a gate controller or another third party controller the jumper should be removed completely (this disables the protection on the relay).

PROGRAMMING

- Enter the **ENGINEER'S CODE**: first time type six times **1 (111111** factory preset) and press **ENTER** (The red LED will illuminate);
- Confirm **ENGINEER'S CODE** (typing again the same) or type the new code (4 to 8 digits) then press **ENTER** (Melody). Pressing twice the **ENTER** button without changing the **ENGINEER'S CODE**, will exit from the programming;
- Enter the code (4 to 8 digits) to enable **RELAY 1** or re-enter the existing code then press **ENTER** (Melody);
- Enter the **RELAY 1** operation time (2 digits 01 to 99 **I.E.** 05=5 seconds, 00= remain open time) or re-enter the existing time then press **ENTER** (Melody);
- Enter the code (4 to 8 digits) to enable **RELAY 2** or re-enter the existing code then press **ENTER** (Melody);
- Enter the **RELAY 2** operation time (2 digits 01 to 99 **I.E.** 05=5 seconds, 00= remain open time) or re-enter the existing time then press **ENTER** (Melody);
- Enter the code (4 to 8 digits) to enable **RELAY 3** or re-enter the existing code then press **ENTER** (Melody);
- Enter the **RELAY 3** operation time (2 digits 01 to 99 **I.E.** 05=5 seconds, 00= remain open time) or re-enter the existing time then press **ENTER** (Melody);
- The system is ready to use (the red LED will be off).

PROGRAMMING NOTES

- After pressing enter following a command, press **ENTER** a further twice to exit the programming menu.

RETURN SYSTEM TO PRESET ENGINEER'S FACTORY CODE

- Turn off power to code lock;
- Keep **ENTER** button pressed while turning the power back on;
- Release **ENTER** button;
- The engineer's code is now set to **111111** (six times one).

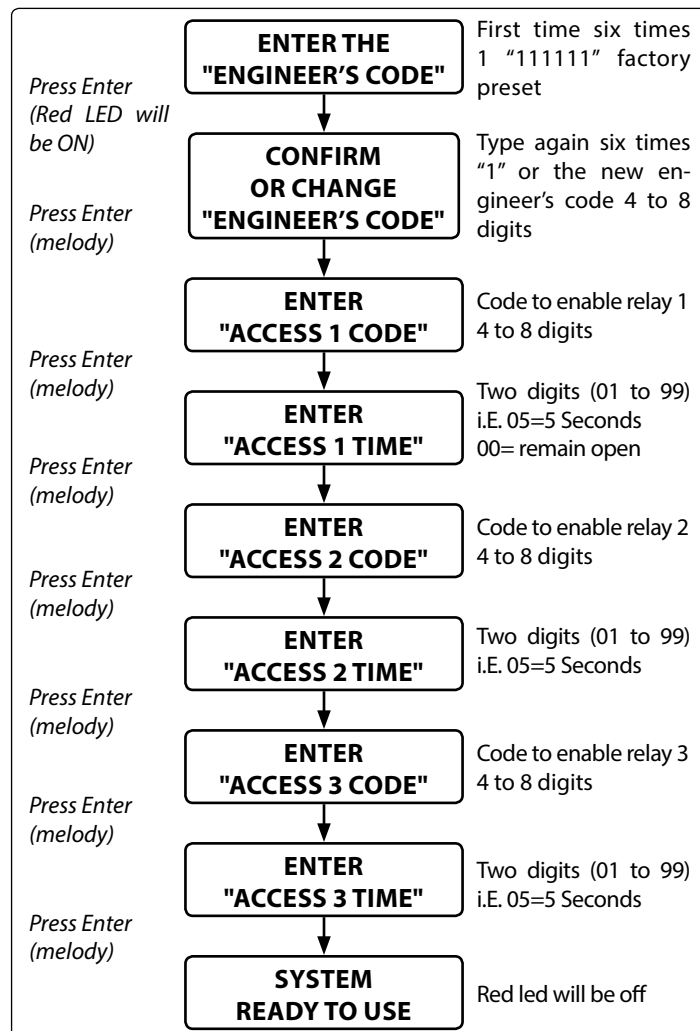

OPERATION

- Type in the programmed code and press **ENTER**;
- If the code is correct, the green LED will illuminate for approx. 2 seconds and the relay relevant to the code will operate for the programmed time;
- If a wrong code is entered, a continuous melody will sound for 4 or more seconds, according to the number of mistakes;
- To switch off any relay while operating, type in the relevant code then press the **CLEAR** button;

OPERATION NOTES

- To operate relays together, set the same code for each relay;
- If a wrong code is entered, the system will lock out for 5 seconds which will increase each time a wrong code is entered. The system will operate only when the correct code is entered.

ADHESIVE GASKET PLACEMENT

Apply the (Y) seal as shown in **Fig. 2**.

ANTI-TAMPERING LOCKS FIXING

Fit the anti-tampering locks (W) as shown in **Fig. 3**.

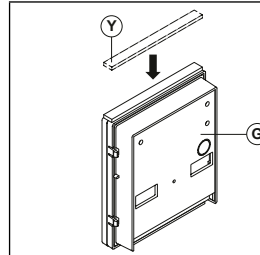

Fig. 2

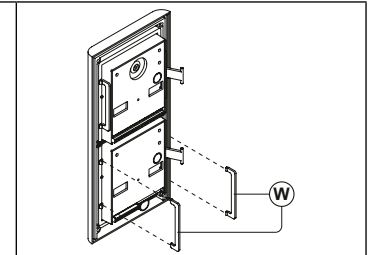

Fig. 3

CONNECTION TERMINALS SIGNALS	
SW2	Relay 2 command signal (active low)
SW1	Relay 1 command signal (active low)
NC3	Relay 3 normally closed contact
NO3	Relay 3 normally open contact
C3	Relay 3 common contact
NC2	Relay 2 normally closed contact
NO2	Relay 2 normally open contact
C2	Relay 2 common contact
NC1	Relay 1 normally closed contact
NO1	Relay 1 normally open contact
C1	Relay 1 common contact
-	12/24Vac/dc power input
+	

**Max
24Vac/dc
3A**

CLEANING OF THE PLATE

Use a clean and soft cloth. Use moderate warm water or non-aggressive cleansers.

Do not use:

- abrasive liquids;
- chlorine-based liquids;
- metal cleaning products.

TECHNICAL SPECIFICATION

Power Supply: 12/24 Vac/dc – 2VA
Power Consumption: Stand-by: 20mA
 Operating: 70mA
Working Temperature: -10 +50° C

4000 Series Surface and flush mounting door station installation

EXAMPLE: INSTALLING A FOUR MODULE OUTDOOR STATION

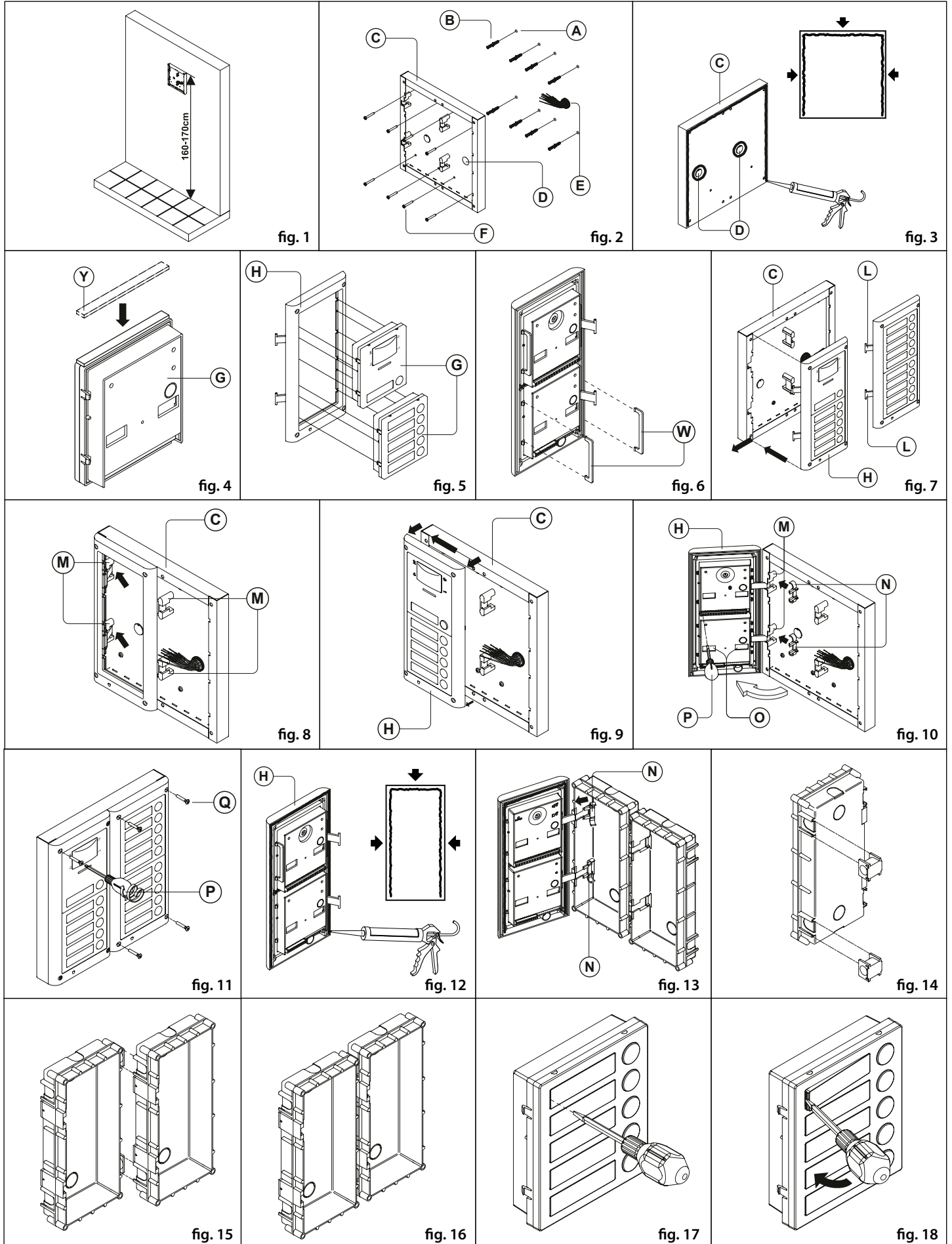

4000 Series Surface and flush mounting door station installation

INSTALLING A SURFACE MOUNT DOOR STATION

- Place the surface box against the wall (165-170cm between the top of the box and the floor level as shown in **Fig. 1**) and mark the fixing holes for the wall plugs and the hole for the cables **(E)** (**fig. 2**). Observe the orientation of the box with the hinge on the left;

⚠ In order to prevent water ingress we highly recommend using a silicon sealant between the wall and the back box **(C) ON THE LEFT, TOP AND RIGHT SIDES ONLY AND AROUND ALL HOLES **(D)**. DON'T USE SILICON SEALANT ON THE BOTTOM SIDE OF THE BACK BOX (Fig.3);**

- As shown on **Fig. 2**, drill the fixing holes **(A)**, insert the wall plugs **(B)** and feed the cables **(E)** through the surface box opening **(D)**, fix surface box **(C)** to the wall using the screws **(F)**;
- Apply the **(Y)** silicon sealant on top of each module as shown in **Fig. 4**;
- Before installation of the module support frame, hook the modules **(G)** to the support frame **(H)** as shown in **Fig. 5** then, as shown in **Fig. 6**, fit the two anti-tampering locks **(W)** for each module (do the same for the second module support frame);
- When you have more than one support frame, hook the support frame to the surface box starting from the left. For convenience we will described how to attach the left frame but the same must be carried out for the right frame. As shown in **Fig. 7**, hook the module support frame **(H)** (complete with modules) to the surface box **(C)** moving the frame as suggested from pointers. Ensure that the pivots **(L)** (**Fig. 7**) go inside the relevant housing **(M)** as shown in **Fig. 8**;
- As shown on **Fig. 9**, pull back the module support frame **(H)** while moving it slightly to the left as suggested by the pointers;
- As shown in **Fig. 10**, open the module support frame **(H)** as suggested by the pointer, hook the hinge locks **(N)** to the hinges **(M)**, make the required connections using the screwdriver provided **(P)** (flat blade end) and make the required adjustment by adjusting the settings (through openings **(O)**) and adjust trimmers;
- Repeat the same operations described above for the second module support frame (or for the third if available);
- When the system has been tested and is working correctly, move back the module support frames carefully, fix them to the surface box using the screwdriver provided **(P)** (torx end) and the pin machine torx screws **(Q)** (**Fig. 11**). **Note: do not over tighten the screws more than is necessary.**

INSTALLING A FLUSH MOUNTING DOOR STATION

When flush mounting and the number of modules is greater than 3, the required back boxes need to be linked together (before embedding them in the wall) as shown on **Fig. 14, 15 and 16**:

- Arrange the back boxes and remove knockouts to allow cables to be fed from one back box to the other;
 - Hook the spacers to first back box then hook the second back box to obtain the result shown on **Fig. 16**;
- Protect the module support frame fixing holes from dust then embed the back box into the wall (165-170cm between the top of the box and the floor level as shown on the **Fig. 1**) feeding the cables **(E)** (**Fig. 2**) through a previously opened hole in the box. Observe the direction of the box ensuring the hinge is on the left and take care that the box profile is in line with the finished wall profile;

⚠ In order to prevent water ingress we highly recommend using a silicon sealant between the module support frame **(H) and the back box ON THE LEFT, TOP AND RIGHT SIDES ONLY. DON'T USE SILICON SEALANT ON THE BOTTOM SIDE OF THE MODULE SUPPORT FRAME (Fig.12);**

- Continue from step 4 of surface mounting instructions, but at step 7 hook the hinge locks **(N)** as shown on **Fig. 13**.

⚠ Note: if additional holes are made in the surface box, oxidation problems may appear unless the unprotected metal is coated with a protective paint.

NOTES

- The screwdriver's blade has two sides, one flat and one torx, to select one of them unplug the blade from the screwdriver body and plug it into the required side.
- The example shows the use of only one back box bottom hole for wires, this is done to keep file drawings clear. Naturally the installer can use the left hole or the right or both if required.

HOW TO REMOVE THE CARD NAME HOLDER

- To avoid damage to the module front plate, tape the side that will be in contact with the screwdriver blade;
- Insert the screwdriver (flat side) into the card-holder hole as shown in **Fig. 17**;
- Move the screwdriver to the left as shown in **Fig. 18** to extract the card name holder;
- Edit the card name then replace it inside the holder and refit: insert the holder inside its housing from the left or right side then push the other side until it clips into place.

Art. 6388 3.5" hands free colour display digital videophone

R01A

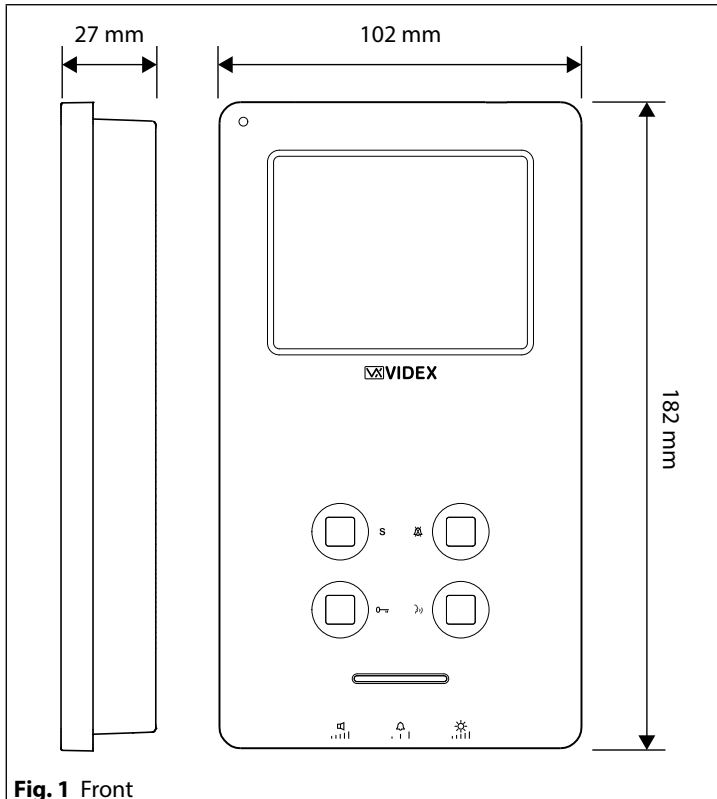

Fig. 1 Front

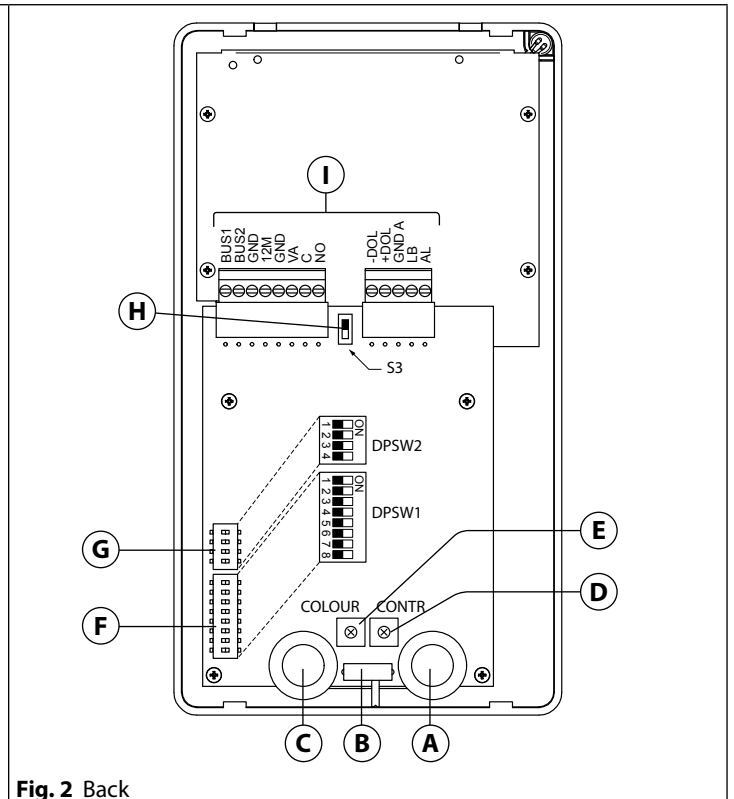

Fig. 2 Back

DESCRIPTION

An intelligent hands free videophone using 3.5" full colour active matrix LCD monitor for VX2300.

Including 4 buttons: Service, Privacy/Bus relay activation/Camera switch/Call reject, Door-open/Intercommunicating call, Answer/OFF/Camera recall/Push to talk plus 3 LED's for visual indication of all functions.



Adjustments & programmable options: call tone volume on 3 levels (low, medium, high), picture hue, brightness and contrast, call tone melody, number of rings, privacy duration and address. Also includes a local bell function. The Art. 6388 is surface mount.



LEGEND

- (A) Speech volume control
- (B) Call tone volume switch
- (C) Brightness control
- (D) Contrast adjustment trimmer
- (E) Hue adjustment trimmer
- (F) 4 Way dip switch bank
- (G) 8 Way dip switch bank
- (H) Bus termination switch
- (I) Connection terminals

PUSH BUTTONS	
S	<p>Service push button When pressed it links internally the terminals C and NO on the connection terminals.</p>
⊗	<p>Privacy ON-OFF push button To enable the function press this button when the videophone is in stand-by. The service is automatically disabled when the programmed time expires (the privacy duration time can be programmed) or manually by pressing again the button.</p>
	<p>Activate bus relay board Art. 2305 push button To activate a bus relay, during a conversation, press this button quickly as many times as the address value of the relay.</p>
	<p>Camera switch push button If the door station uses the Art. 4303N plus the Art. 4330N, pressing this button during a conversation switches the video signal coming from the camera module to the video signal coming from the camera module input for external camera. During the conversation, press and keep pressed the button until the camera switches. Repeat the operation to switch back to main camera.</p>
	<p>Call Reject button During an incoming call, press this button to reject the call. The visitor doesn't receive any warning of the call rejected.</p>
⌘	<p>Door open push button Press this button to open the door when you are in conversation or you are receiving a call.</p>
	<p>Intercommunication push button For an intercommunicating call, press as many times as the extension or address value to call (see SW2 Intercommunication Settings).</p>

PUSH BUTTONS	
})	<p>Answerpush button On an incoming call, operation of this button allows the user to answer and converse with the visitor. The relevant LED will illuminate.</p>
	<p>Switch off button With the system switched on (monitor on), momentary operation of the button will switch the video monitor off. The videomonitor will also automatically switch off after a time delay if the button is not pressed. The relevant LED will switch off.</p>
	<p>Camera Recall push button Press as many times as the DEVICE N. of the door station to switch on.</p>
	<p>Simplex button Pressing and holding the button for more than 3 seconds will switch the videomonitor into SIMPLEX speech mode. Press and hold the button to speak to the caller (}) LED will flash rapidly), release the button to listen (}) LED will flash slowly). If the button is not pressed for 10 seconds the videomonitor will switch off. The videomonitor will revert to duplex speech when another call is made.</p>

LEDS	
	<p>Privacy on LED It illuminates when the privacy service is enabled.</p>
	<p>Generic use LED It is controlled from the terminals +DOL and -DOL. Normally used to signal the door status (open or closed).</p>
})	<p>ON LED It illuminates when the videophone is switched ON.</p>

CONTROLS	
	<p>Speech volume control (sliding wheel).</p>
	<p>Call tone volume control (3 levels).</p>
	<p>Brightness control (sliding wheel).</p>
COLOUR	<p>Colour intensity control trimmer (rotate left to increase or right to decrease).</p>
CONTR	<p>Contrast control trimmer* (rotate left to increase or right to decrease). <small>*Not available in some LCD versions.</small></p>
S3	<p>Bus termination switch (lower position = BUS termination active, upper position = BUS termination disabled).</p>

PROGRAMMING

The videophone setup consists of the following settings:

- Number of rings;
- Melody selection;
- Privacy duration;
- Unit address (1..127, switches 1 to 7 of **SW1**);
- Bus Termination (open or close, **S3** switch);
- Intercommunication mode (between apartments or within apartment, switch 1 of **SW2**);
- Extension address (1..4, switches 2,3 of **SW2**);
- Slave mode (switch 4 of **SW2**).

The programming of the number of rings, melody and privacy duration are carried out through the videophone push buttons, all other settings are carried out on the two dip-switch banks (**SW1** and **SW2**) on the rear side of the video monitor (all the settings can be done without opening the videophone).

It is necessary to remove temporary the power supply after making any programming changes.



NUMBER OF RINGS, MELODY SELECTION AND PRIVACY DURATION

All programming options are available only when the system is in stand-by.

NUMBER OF RINGS.

- Keep pressed the }) button until the two LEDs }) and  switch on.
- Press the }) button for the number of times corresponding to the required number of rings to set. A beep confirms each time the button is pressed.
- Once the required number of rings is reached, wait approx 5 seconds for the two LED's to switch off. The new value is stored.

MELODY SELECTION

- Keep pressed the  button until the two LEDs }) and  switch on. The unit emits the current selected melody.
- Press the  button and keep it pressed to listen the next melody. Repeat the operation until the required melody is found.
- Once the required melody is found, wait approx 5 seconds for the two LED's to switch off. The new melody is set.

Art. 6388 3.5" hands free colour display digital videophone

PRIVACY DURATION

- Keep pressed the button until the two LEDs and are switched on.
- Press the button for the number of times corresponding to the required privacy duration to set. Each time the button is pressed, the duration is increased by 15 minutes: **i.e.** to set 2 hours, press the button 8 times.
- Once the required privacy time is reached, wait approx 5 seconds for the two LED's to switch off. The new duration is set.

VIDEOPHONE ADDRESS – SW1.1..7

The table below shows how to set the address of the videophone. Considering that ON = 1 and OFF = 0, multiply each digit for the relevant decimal weight then sum values obtained to get the address: **E.g.** as highlighted in the table OFF, ON, OFF, OFF, ON, OFF, ON in binary is equal to 0100101 then multiplying each digit for the relevant decimal weight you obtain the address that is 37.



SW1.1..7

SWITCHES STATUS							BINARY CODE - DECIMAL WEIGHT							ADDRESS
7	6	5	4	3	2	1	64	32	16	8	4	2	1	
OFF	OFF	OFF	OFF	OFF	OFF	ON	0	0	0	0	0	0	1	1
OFF	OFF	OFF	OFF	OFF	ON	OFF	0	0	0	0	0	1	0	2
OFF	OFF	OFF	OFF	OFF	ON	ON	0	0	0	0	0	1	1	3
OFF	OFF	OFF	OFF	ON	OFF	OFF	0	0	0	0	1	0	0	4
OFF	ON	OFF	OFF	ON	OFF	ON	0	1	0	0	1	0	1	37
ON	ON	ON	ON	ON	ON	ON	1	1	1	1	1	1	1	127

Note: The maximum number of units allowed is 100 but the address of each unit can be a value between 1 and 127.

VIDEOPHONE END OF LINE TERMINATION – S3

Looking at the videophone from the rear:

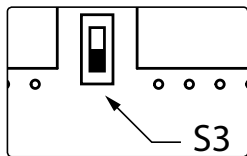

Move the switch **S3** to the lower position to disable the bus termination.

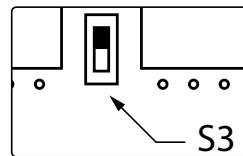

Move the switch **S3** to the upper position to enable the bus termination.

In case of more units (intercoms, videophones or video monitors) in a parallel connection (bus wires are connected to the terminals of the first unit then from this to the second and so on up to 4 units max) the BUS termination must be enabled only for the last unit in the chain while on all other units it must be set to disabled.

INTERCOMMUNICATION MODE – SW2.1

This switch establishes the intercommunication mode: in OFF position (default) intercommunication is between units in the same apartment (same addresses but different extension); in ON position the intercommunication is between units in different apartments (different addresses).



On installations where there are more than one intercom/videophone in the same apartment and intercommunication between different apartments is required, only one intercom/videophone may be set with this function (SW2.1=ON, SW2.2=OFF, SW2.3=OFF). The other intercom/videophones in the apartment must be set for local intercommunication with extension addresses "2-4" (slaves). From the intercom/videophone set for intercommunication with other apartments it will not be possible to intercommunicate within the apartment but slave extensions 2-4 will be able to intercommunicate with each other within the apartment.

EXTENSION NO – SW2.2..3

If the intercommunication between apartments is enabled (switch 1 of **SW2** = ON) leave these two switches in default position (both to OFF). Otherwise, if the intercommunication is between the same apartment (switch 1 of **SW2** = OFF), set the extension addresses starting always from 1. During the external call, all video monitors in the same flat will ring but the video will be shown only from the videophone with extension address 1.



SW2.2..3

2	3	EXTENSION NO.
OFF	OFF	1 (default, master)
ON	OFF	2 (slave)
OFF	ON	3 (slave)
ON	ON	4 (slave)

SLAVE MODE - SW2.4

This set up concerns the answering mode of the video monitor when there is more than one unit (max 4) in the same apartment. OFF (default) = during a call, only the video monitor with extension 1 (master) will show the video. ON = the video monitor will be switched on independently of the extension address: in this case the video monitor must be supplied locally using a power supply Art. 2321 and connecting respectively **BUS+** to terminal **+VAUX** and **BUS-** to terminal **GND** on the connection terminals (the local power supply is required for each black & white slave videophone or starting from the third slave videophone when they are all colour videophones).



If you set for one slave videophone, you must set ON the same switch also for the relevant master videophone.

CONNECTION TERMINALS SIGNALS

BUS1	Bus input	
BUS2	Bus input	
GND	Ground	
12M	+12Vdc power supply input (Art. 323/12 or Art. AMR2-12) for version with Memory Board option or auxiliary power supply input (to be used when two or more slave monitors are ringing together with the switch 4 of SW3 is set to ON)	
GND	Ground	
VA	+30Vdc power supply input (Art. 2321) to be used when two or more slave monitors are ringing together with the switch 4 of SW3 set to ON	
C	Dry contact. Internally linked to NO when the S button is pressed.	Max 35Vdc, 50mA
NO	Dry contact. Internally linked to C when the S button is pressed.	
-DOL	Auxiliary LED power supply input (ground)	
+DOL	Auxiliary LED power supply input (+12Vdc)	
GND A	Ground output for use in combination with AL & LB active low inputs	
LB	Local bell input (active low)	
AL	Alarm input (not implemented yet)	

TECHNICAL SPECIFICATION

Housing/Mounting: 6300 Series Videophones surface mount

Push buttons: Yes, 4

Programming: Yes, carried out by the buttons and the dip-switches located on the rear of the videophone

Controls: Call tone volume, picture hue, brightness and contrast

Power Supply: Supplied by the BUS line

Power consumption: Stand-by: 0.2mA
 Operating: 115mA

Working Temperature: -10 +50 °C

MEMORY BOARD

This device is also available in the version with memory board (Art. 6388/VM). If you have that version, please refer to the "6200, 6300, 6400 and 6700 Series Memory Board" user manual (in English and Italian) for installation and use.

The manual is available for download: click/tap or scan the QR code.



6300 Series Wall mounting instructions

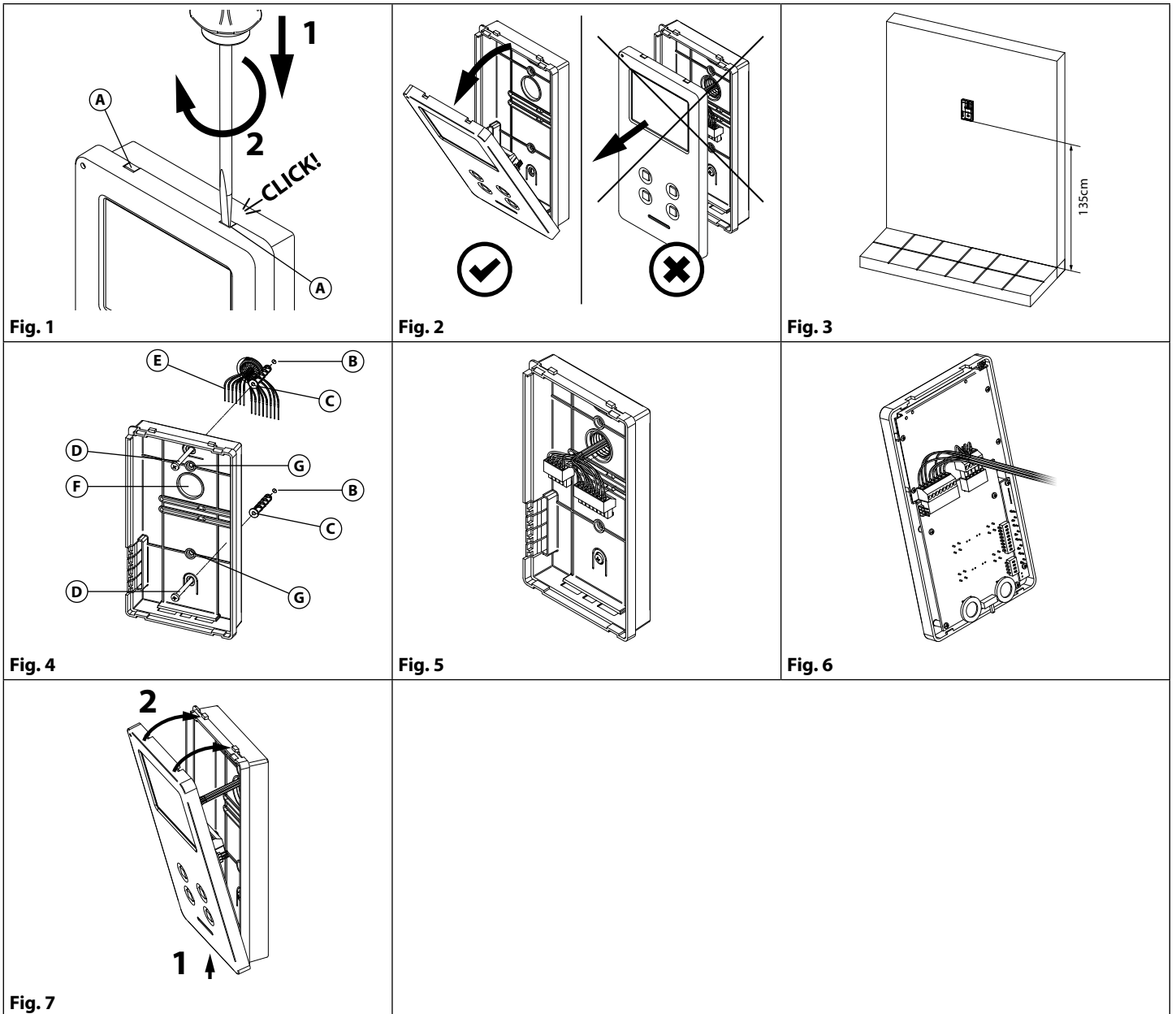

- In order to install the videophone, it is necessary to remove the cover, which contains all the electronics, from the base: insert a 5.5mm flat screw driver into the clip (A) then rotate clockwise until you listen a "CLICK!". Repeat the same operation with the other clip as shown in Fig. 1.
- Pull outwards the upper part of the cover as shown in Fig. 2. **Don't pull the cover straight.**
- Put the base of the unit on the wall at approx 135cm from the finished floor (Fig. 3) to match the points for the fixing holes (B) (Fig. 4) remembering that the wires (E) (Fig. 4) must be fed through the large hole (F) (Fig. 4). If you use the flush mounting box 503, embed it into the wall vertically at approx. 140cm from the finished floor and the base.
- Following Fig. 4, make the holes (B), insert the wall plugs (C) and fix the base with the screws (D) feeding the wires (E) through the hole (F). If you have used the box 503, fix the base to the wall through the holes (G) using the screws (D).
- As shown in Fig. 5, connect the wires to the removable terminals following the provided installation diagram. Connect the terminal blocks to the electronics contained in the cover as shown in Fig. 6. Test system before closing.
Contrast and hue trimmers can be adjusted only if the videophone is open. To activate the display and see changes use the "Camera Recall" function by pressing  button.
Note: while testing the system, it is advisable to hold the cover with your hand.
- Once testing is complete and all the necessary adjustments are made, close the unit as shown in Fig. 7: first hook in the bottom and then the upper part until you hear a "CLICK!".

Art. 2321-2321/P Power supplies for VX2300

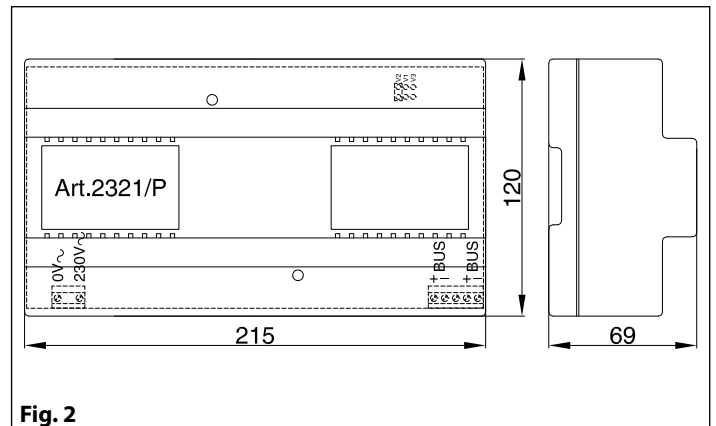
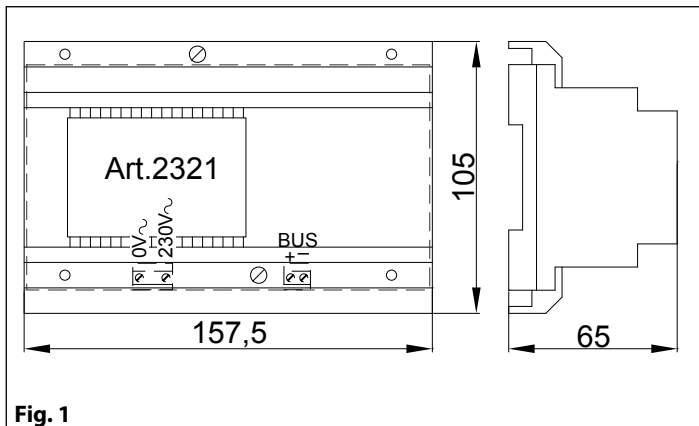

DESCRIPTION

These two power supplies are specifically designed for the VX2300 digital system. The Art. 2321 can be used for systems with 1 entrance up to 20 users while the Art. 2321/P is for systems with more than 1 entrance and up to 100 users.

CONNECTION TERMINALS AND JUMPERS

0	Mains input
~230V	
BUS +	BUS terminals
BUS -	
BUS +	BUS terminals (only Art. 2321/P)
BUS -	
V1	Jumper to adjust the output voltage (only Art. 2321/P). V1=Low, V2=Medium, V3=Maximum. Set to maximum (V3) when the unit is used together with Art. 2301N, otherwise leave in a low or medium position.
V2	
V3	

CONNECTION TO MAINS AND POWER SUPPLY MOUNTING INSTRUCTIONS

This equipment is not suitable for use in locations where children are likely to be present.

The system must be installed according to national rules in force, in particular we recommend to:

- Connect the system to the mains through an **all-pole circuit breaker** which shall have contact separation of at least 3mm in each pole and shall disconnect all poles simultaneously;
- The **all-pole circuit breaker** shall be placed for easy access and the switch shall remain readily operable.

POWER SUPPLY INSTALLATION

- Remove the terminal side covers by unscrewing the retaining screws;
- Fix the power supply to a DIN bar or directly to the wall using two expansion type screws;
- Switch off the mains using the circuit breaker mentioned above and then make the connections as shown on the installation diagrams;
- Check the connections and secure the wires into the terminals;
- Replace the terminal covers and fix them using the relevant screws;
- When all connections are made, restore the mains.

SPECIFICATION

Housing/Mounting: 9 Module A Type DIN box (Art. 2321) – 12 Module A Type DIN box (Art. 2321/P) / DIN Bar or directly to the wall

Push Buttons: N/A

Programming: N/A

Controls: Voltage amplification (3 levels)

Power Supply: 230 Vac

Working Temperature: -10 +50°C

ART. 2321 - ELECTRICAL DATA

Mains voltage: 230 Vac ~ 50/60 Hz
Output voltage: 32 Vdc 0.8 A
Internal fuse: -

ART. 2321/P - ELECTRICAL DATA

Mains voltage: 230 Vac ~ 50/60 Hz
Output voltage: 35 Vdc 1.5 A
Internal fuse: T 350 mA L 250

Art. 2322 Power supply converter from BUS line to 12 Vdc

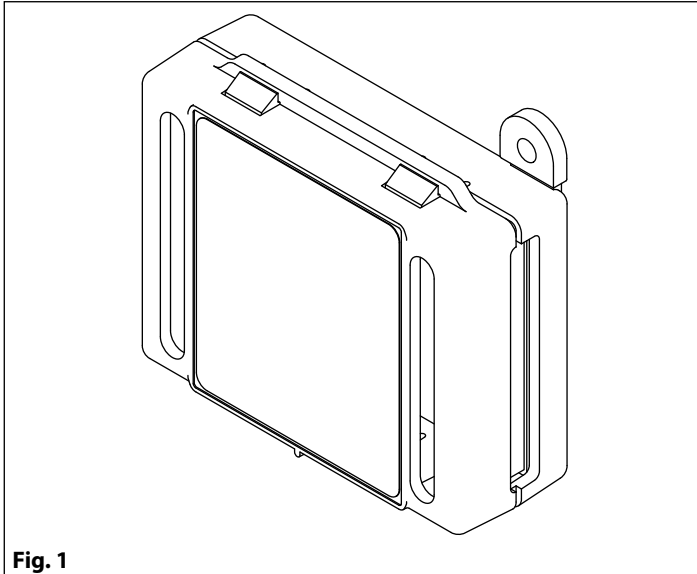

Fig. 1

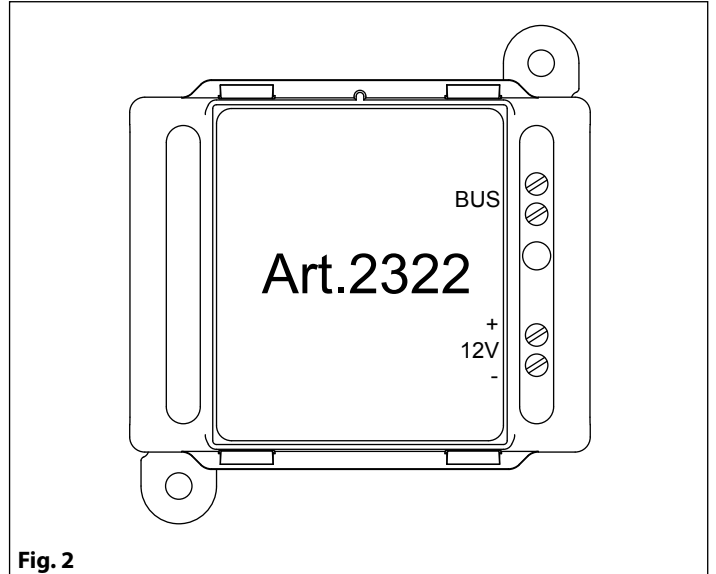

Fig. 2

DESCRIPTION

When this unit is connected to the BUS line it generates a +12Vdc – 100mA power source. This unit can be used to supply peripherals such as the Art. 4800 or Art. 4800M without the need for an additional power supply.

Please note: The peripherals must not require more than 100mA.

CONNECTION TERMINALS

BUS	BUS line inputs
BUS	
12V+	12Vdc – 100mA output
12V- (0V)	

TECHNICAL SPECIFICATION

Housing/Mounting:	Plastic box 50x60x20mm / direct wall mounting
Push buttons:	N/A
Programming:	N/A
Controls:	N/A
Power supply:	Supplied by the BUS line
Working temperature:	-10° +50° C

Art. 125 Call expansion module

DESCRIPTION

This module must be used in combination with speaker units Art. 4333 with firmware release 2.0 or higher. The module, in combination with standard 4000 series button expansion modules (Art. 4842, Art. 4843, Art. 4844 and Art. 4845), allows to add up to 5 call buttons to the call buttons built-in the speaker unit to reach a maximum of 7 call buttons. To supply the LED of the button expansion modules make the connection as shown in figure 1. From Art. 4333 firmware version 2.3 or later, the switch n.6 sets the addressing order of the buttons so you can sort them as shown above.

Please follow the directions in the diagram to supply the push buttons modules.

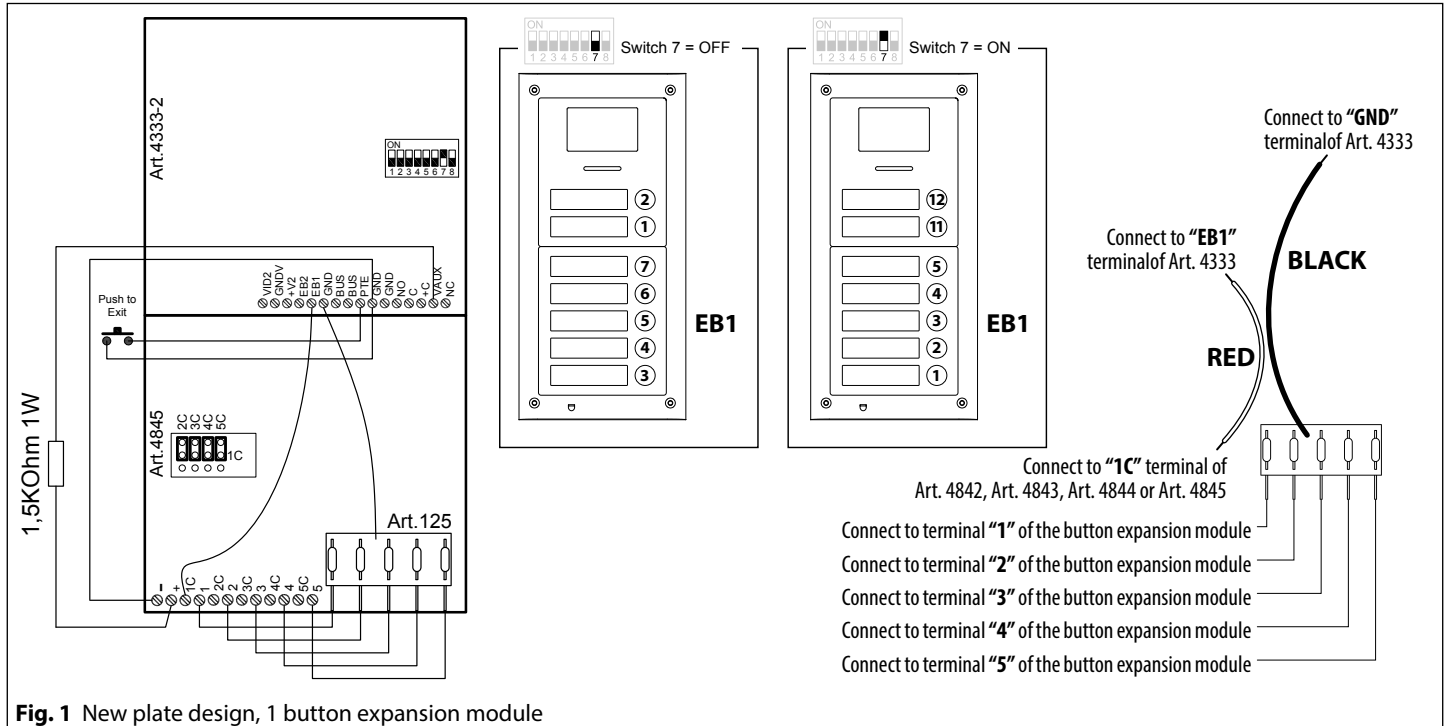

Fig. 1 New plate design, 1 button expansion module

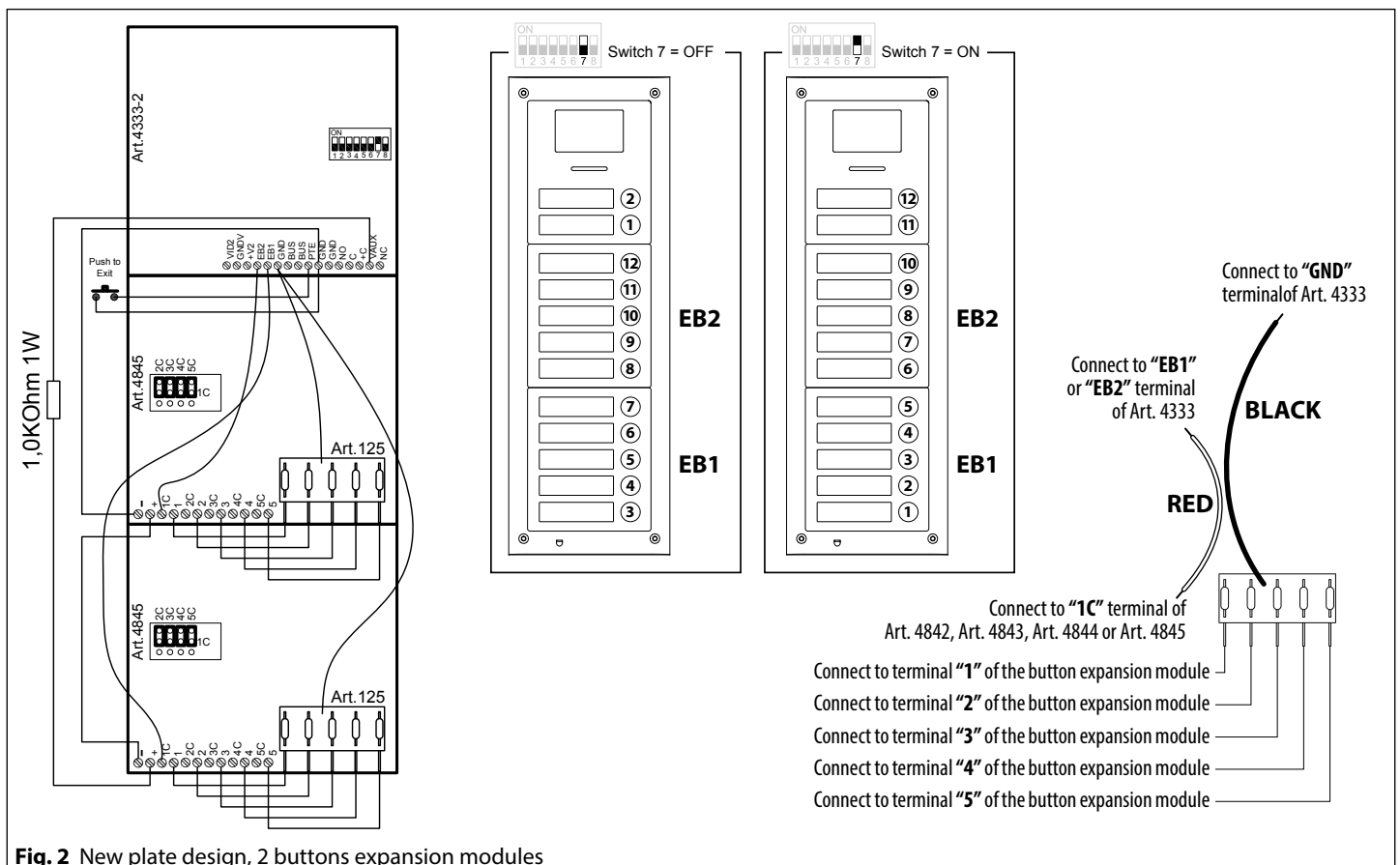

Fig. 2 New plate design, 2 buttons expansion modules

Art. 125 Call expansion module

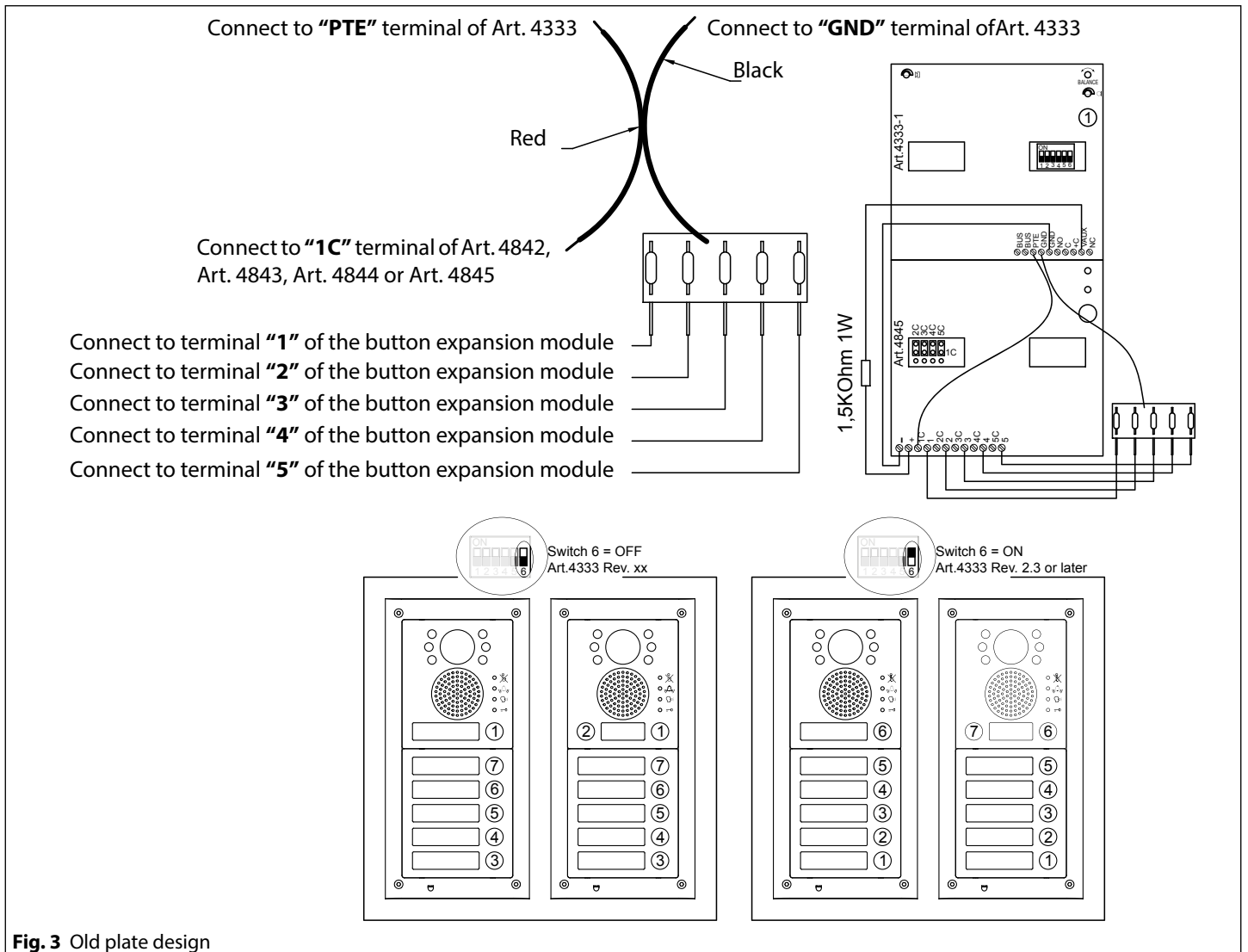
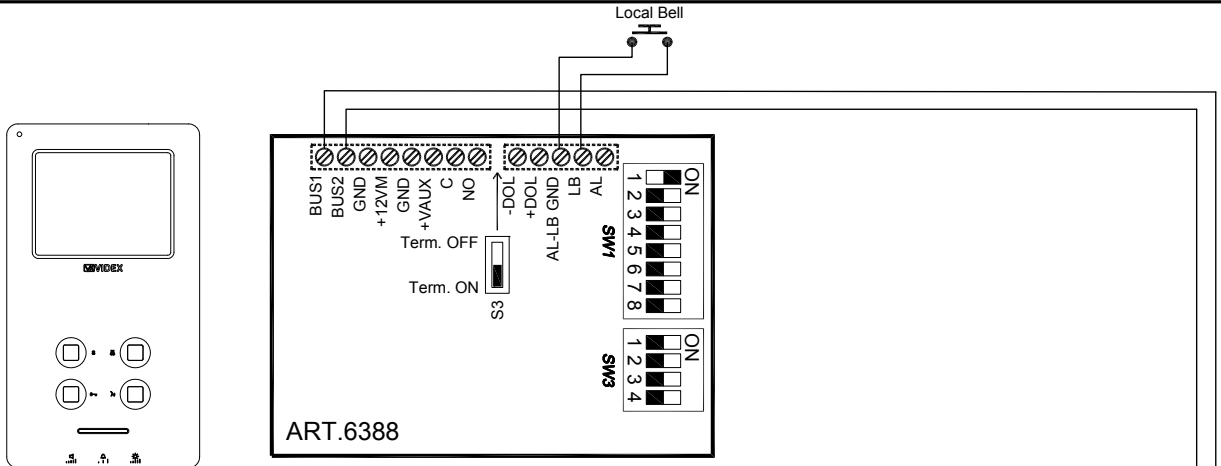

Fig. 3 Old plate design

TECHNICAL SPECIFICATION

- Housing/Mounting:** 5 resistors module / fix to button expansion module
- Push buttons:** N/A
- Programming:** N/A
- Controls:** N/A
- Power supply:** N/A
- Working temperature:** -10° +50° C



ART.6388
 Extension N. 1
 Videophone: 1

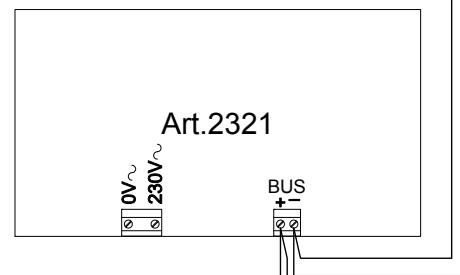

N.B.
 Dopo ogni cambiamento nella programmazione del posto esterno, del videocitofono o del relè, è necessario togliere l'alimentazione al sistema e ripristinarla affinché le variazioni vengano recepite dai rispettivi dispositivi.

After each change on the programming of the door station, videophone or any other device connected to the system it is necessary to restart the system (power off then power on).

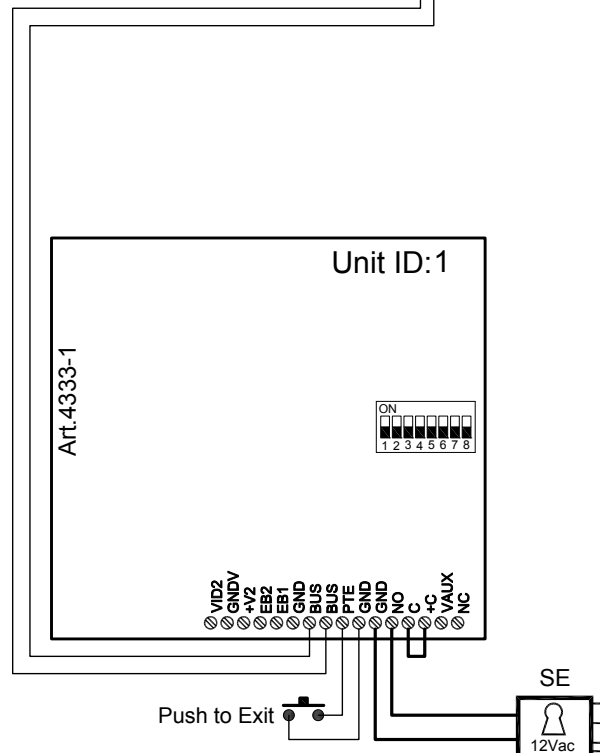
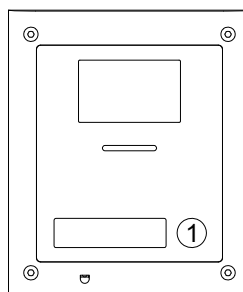

Title: ESVK-1/6388, ESVK-1S/6388 One Way Videokit		Data creazione: 17/02/2017	Foglio 1 / 1
Titolo: ESVK-1/6388, ESVK-1S/6388 Videokit Monofamiliare		Data modifica: 20/02/2017	
Videx Electronics S.p.A. Via del Lavoro 1, 63946 Monte Giberto (FM) Phone: +39 0734 631669 - Fax +39 0734 631669 www.videx.it - info@videx.it		Autore: Roberto Gambini	
Notes: .		Cod. File: esvk-63h-001.dwg	

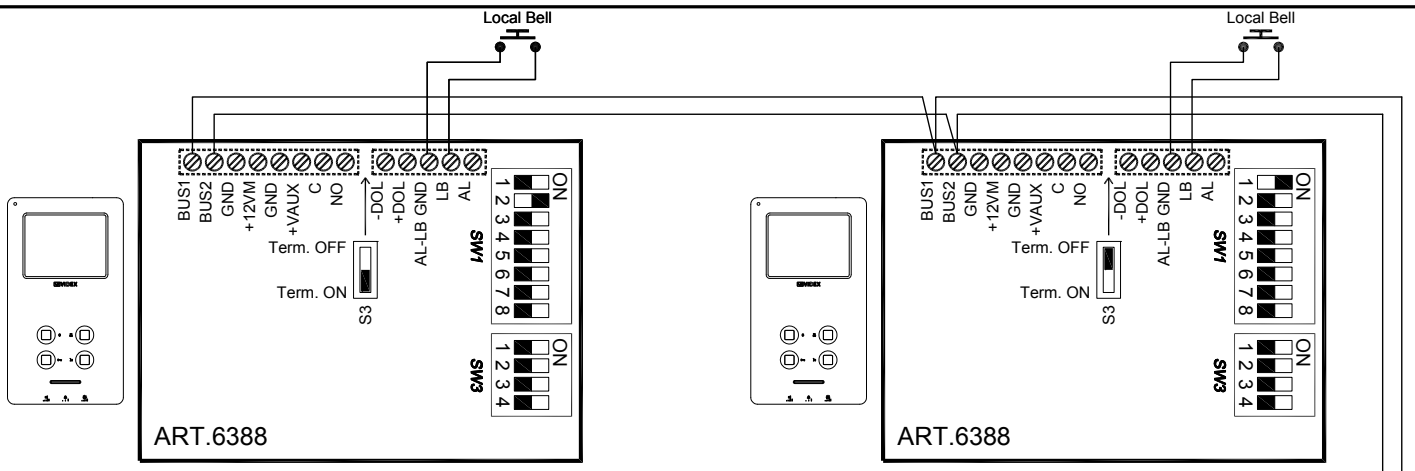

Extension N. 1
Videophone: 2

Extension N. 1
Videophone: 1

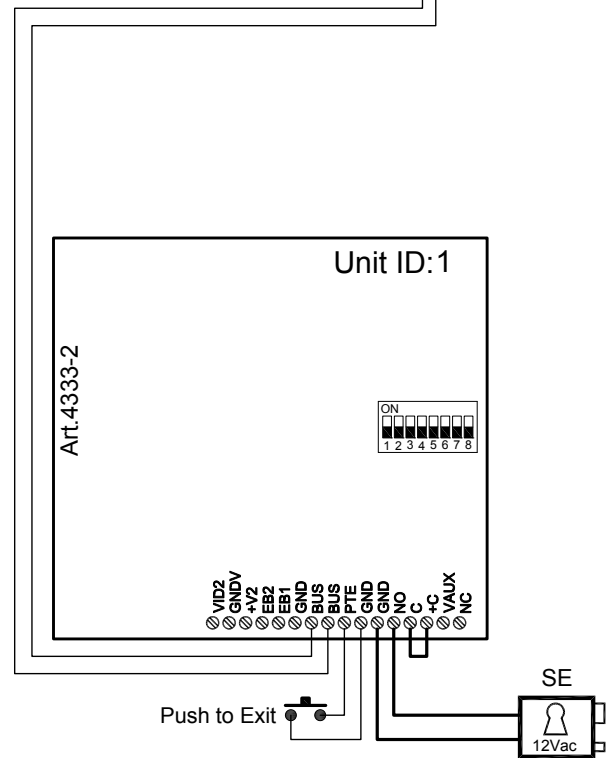
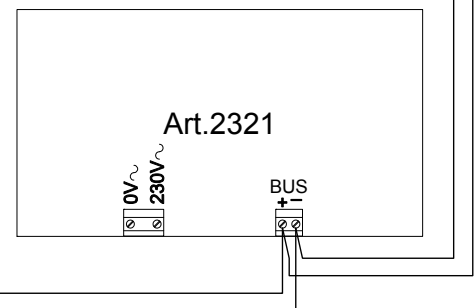

N.B.
Dopo ogni cambiamento nella programmazione del posto esterno, del videocitofono o del relè, è necessario togliere l'alimentazione al sistema e ripristinarla affinché le variazioni vengano recepite dai rispettivi dispositivi.

After each change on the programming of the door station, videophone or any other device connected to the system it is necessary to restart the system (power off then power on).

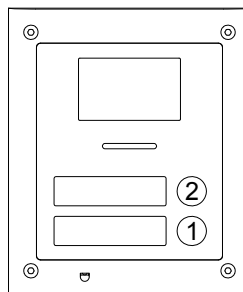

Title: **ESVK-2/6388, ESVK-2S/6388 Two Way Videokit**

Titolo: **ESVK-2/6388, ESVK-2S/6388 Videokit Bifamiliare**

Videx Electronics S.p.A.
Via del Lavoro 1, 63946 Monte Giberto (FM)
Phone: +39 0734 631669 - Fax +39 0734 631669
www.videx.it - info@videx.it

Notes:

Note:

Data creazione: **17/02/2017**

Data modifica: **20/06/2018**

Autore: **Roberto Gambini**

Cod. File: **esvk-63h-002.dwg**

Foglio **1 / 1**

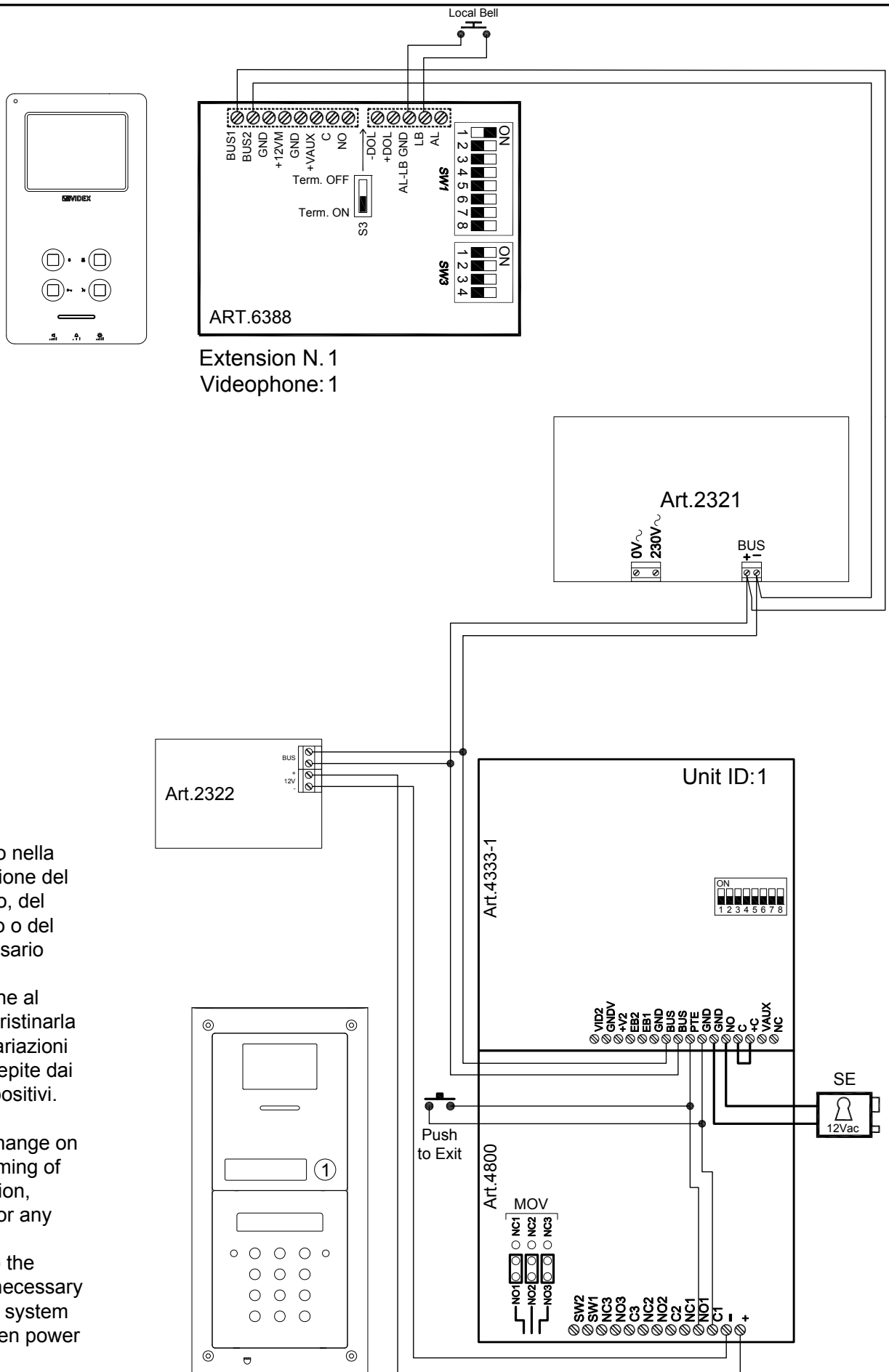

Extension N. 1
Videophone: 1

Art.2321

Art.2322

Unit ID: 1

Art.4333-1

Art.4800

SE
12Vac

N.B.
Dopo ogni cambiamento nella programmazione del posto esterno, del videocitofono o del relè, è necessario togliere l'alimentazione al sistema e ripristinarla affinché le variazioni vengano recepite dai rispettivi dispositivi.

After each change on the programming of the door station, videophone or any other device connected to the system it is necessary to restart the system (power off then power on).

Title: ESVKC-1/6388, ESVKC-1S/6388 One Way Videokit

Data creazione: 17/02/2017 Foglio 1 / 1

Titolo: ESVKC-1/6388, ESVKC-1S/6388 Videokit Monofamiliare

Data modifica: 20/02/2017

Videx Electronics S.p.A.
Via del Lavoro 1, 63946 Monte Giberto (FM)
Phone: +39 0734 631669 - Fax +39 0734 631669
www.videx.it - info@videx.it

Notes:

Autore: Roberto Gambini

Note:

Cod. File: esvk-63h-003.dwg

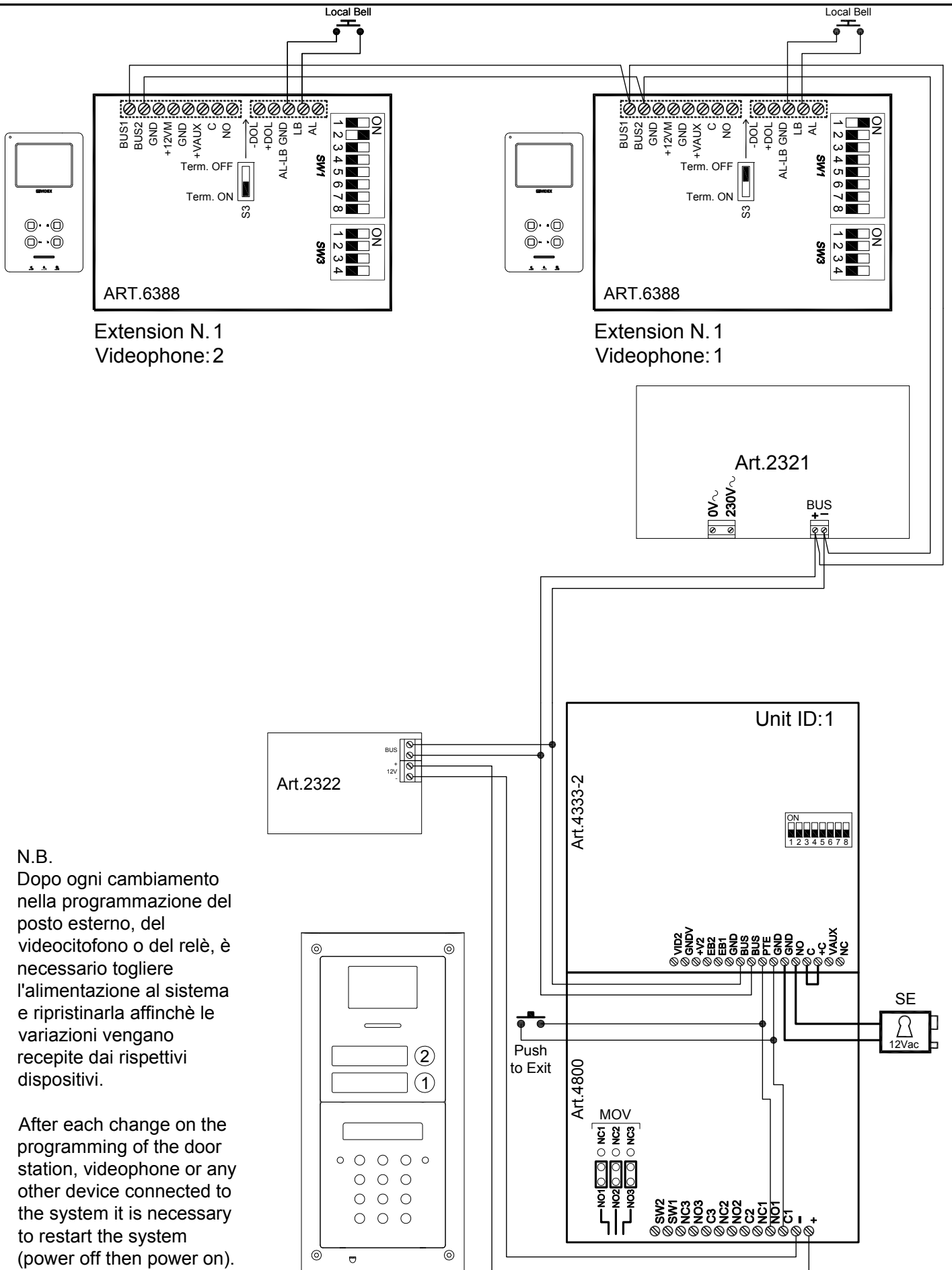

N.B.
 Dopo ogni cambiamento nella programmazione del posto esterno, del videocitofono o del relè, è necessario togliere l'alimentazione al sistema e ripristinarla affinché le variazioni vengano recepite dai rispettivi dispositivi.

After each change on the programming of the door station, videophone or any other device connected to the system it is necessary to restart the system (power off then power on).

Title: **ESVKC-2/6388, ESVKC-2S/6388 Two Way Videokit**

Title: **ESVKC-2/6286, ESVKC-2S/6286 Videokit Bifamiliare**

Videx Electronics S.p.A.
 Via del Lavoro 1, 63846 Monte Giberto (FM)
 Phone: +39 0734 631669 - Fax +39 0734 631669
 www.videx.it - info@videx.it

Notes:

Note:

Data creazione: **17/02/2017**

Data modifica: **20/02/2017**

Autore: **Roberto Gambini**

Cod. File: **esvk-63h-004.dwg**

Foglio **1 / 1**

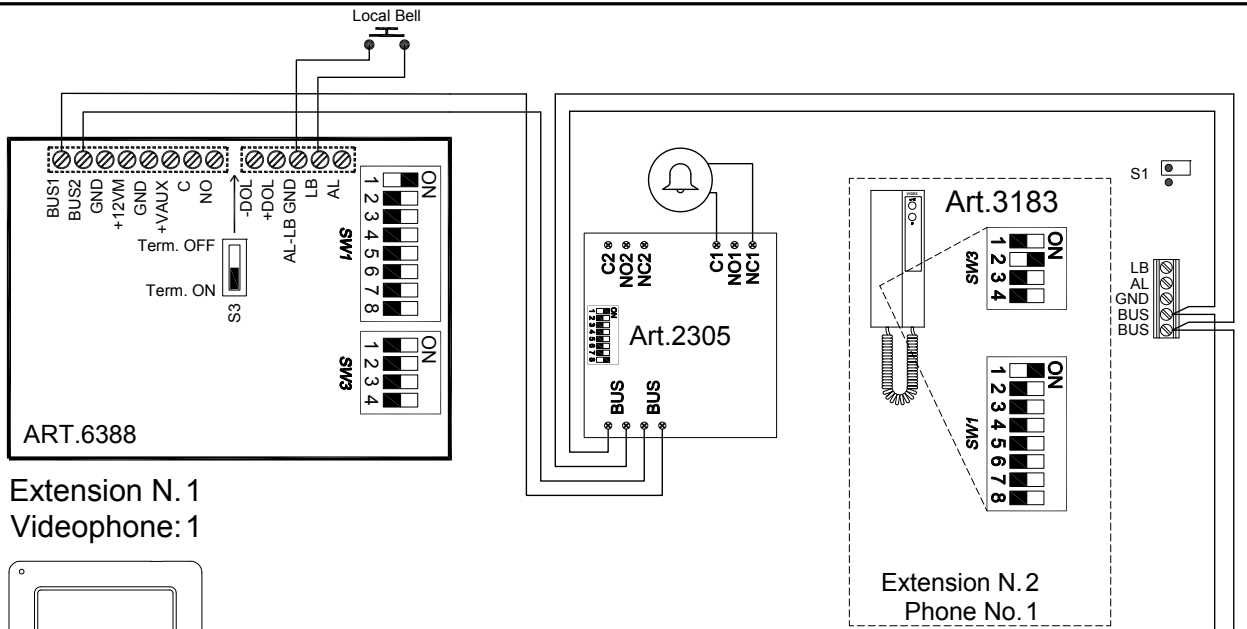

Extension N. 1
Videophone: 1

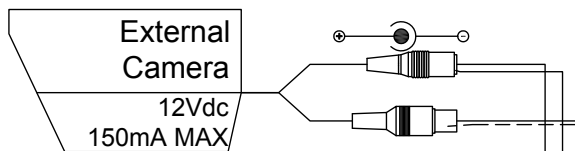
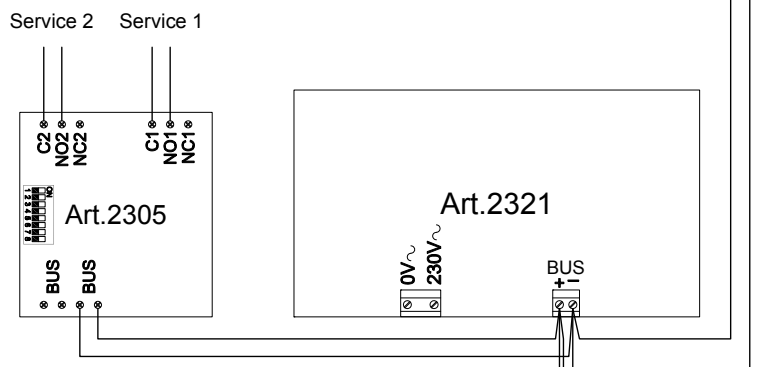
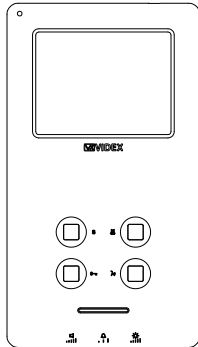

N.B.
Dopo ogni cambiamento nella programmazione del posto esterno, del videocitofono o del relè, è necessario togliere l'alimentazione al sistema e ripristinarla affinché le variazioni vengano recepite dai rispettivi dispositivi.

After each change on the programming of the door station, videophone or any other device connected to the system it is necessary to restart the system (power off then power on).

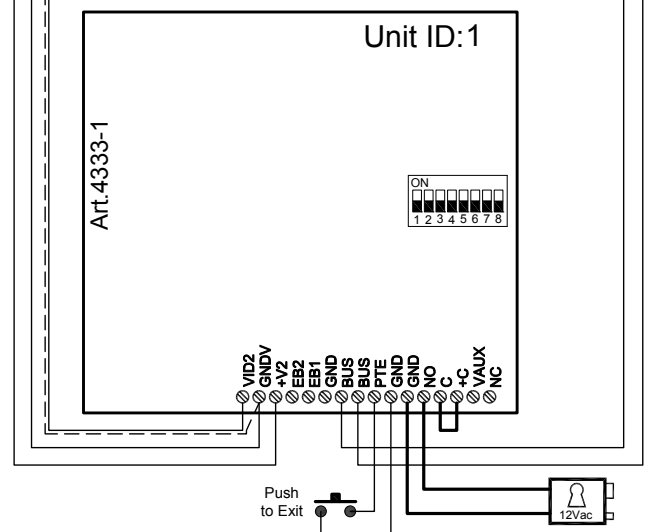
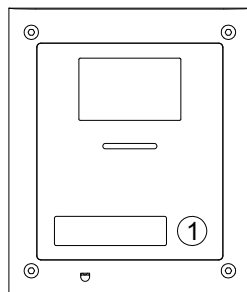

Title: ESVK-1/6388, ESVK-1S/6388 One Way Videokit with additional intercom, relay to control an additional sounder, relay for two additional services and external camera		Data creazione: 17/02/2017	Foglio 1 / 1
Titolo: ESVK-1/6388, ESVK-1S/6388 Videokit Monofamiliare con citofono addizionale, relè per l'estensione della suoneria, relè per due servizi addizionali e telecamera esterna		Data modifica: 20/02/2017	
Videx Electronics S.p.A. Via del Lavoro 1, 63946 Monte Giberto (FM) Phone: +39 0734 631669 - Fax +39 0734 631669 www.videx.it - info@videx.it		Autore: Roberto Gambini Cod. File: esvk-63h-005.dwg	

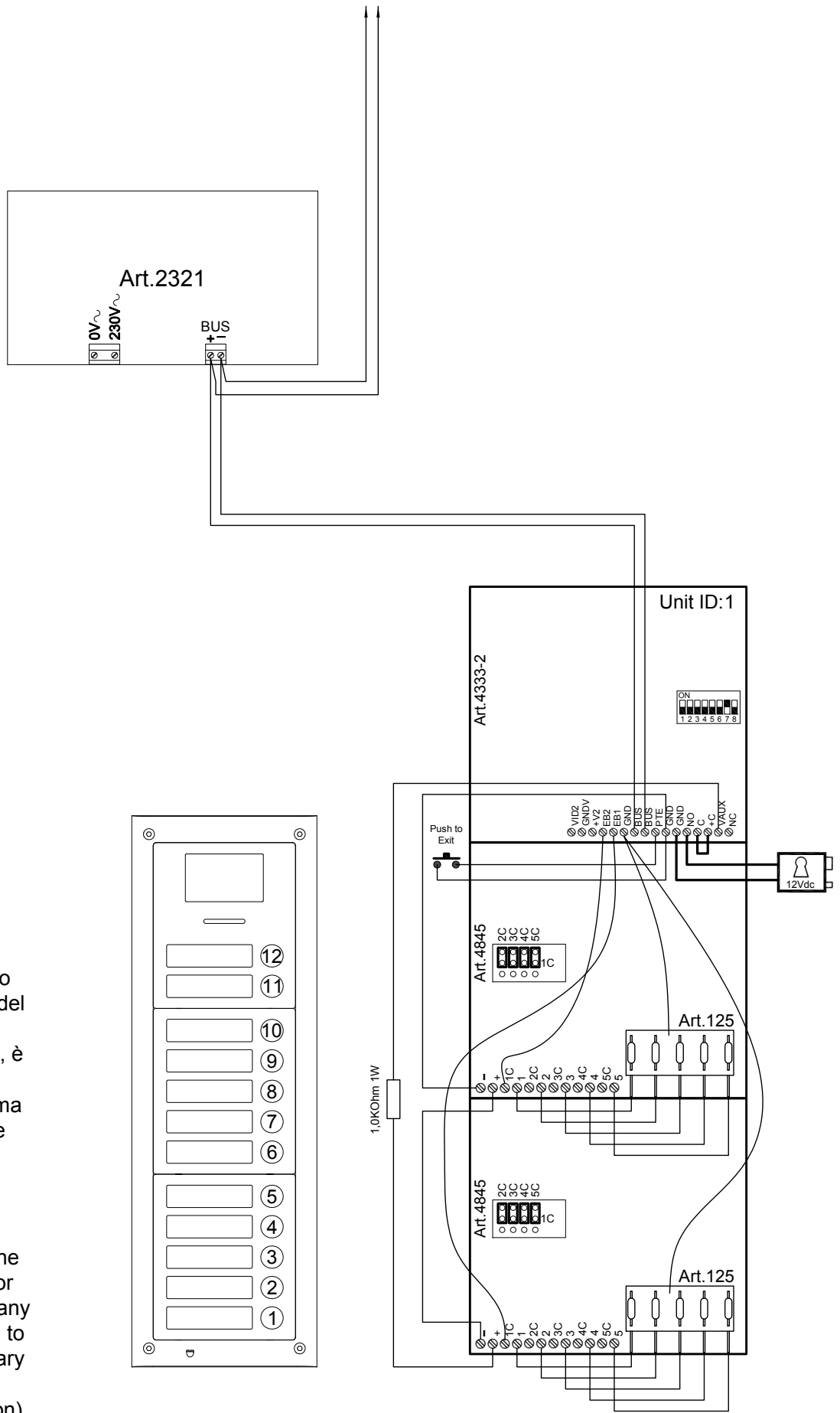

N.B.
 Dopo ogni cambiamento nella programmazione del posto esterno, del videocitofono o del relè, è necessario togliere l'alimentazione al sistema e ripristinarla affinché le variazioni vengano recepite dai rispettivi dispositivi.

After each change on the programming of the door station, videophone or any other device connected to the system it is necessary to restart the system (power off then power on).

Title: ESVK videokit expanded up to 12 apartments system		Data creazione: 20/02/2017	Foglio 1 / 1
Titolo: Videokit ESKV con espansione fino a 12 appartamenti		Data modifica: 20/06/2018	
Videx Electronics S.p.A. Via del Lavoro 1, 63946 Monte Giberto (FM) Phone: +39 0734 631669 - Fax +39 0734 631669 www.videx.it - info@videx.it		Autore: Roberto Gambini	
Notes: .		Cod. File: esvk-63h-006.dwg	

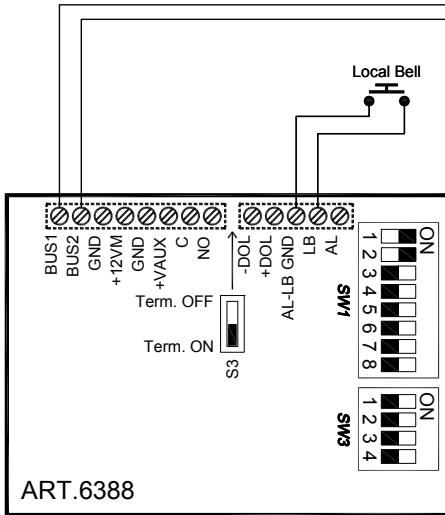
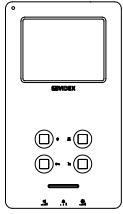

ART.6388

Extension N. 1
Videophone: 3

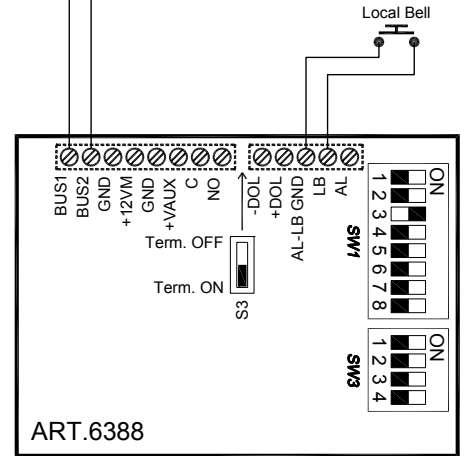

ART.6388

Extension N. 1
Videophone: 4

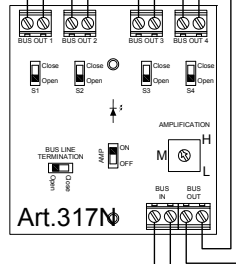

Art.317

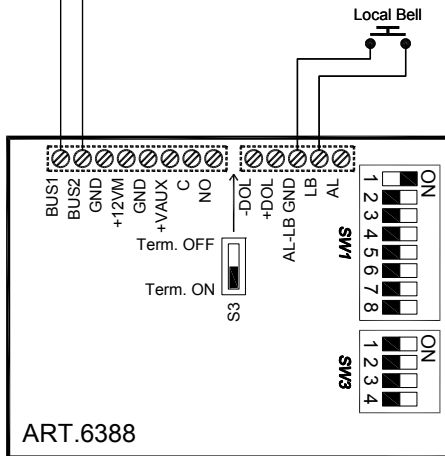
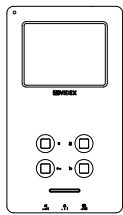

ART.6388

Extension N. 1
Videophone: 1

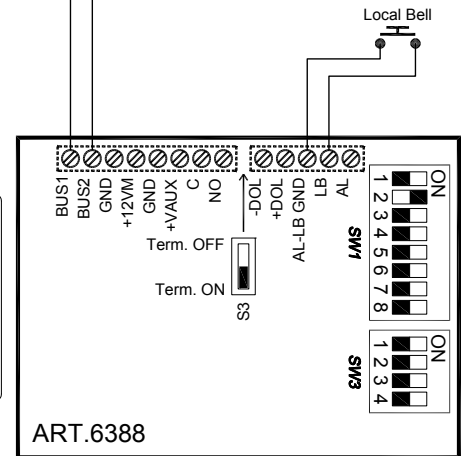
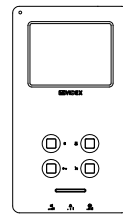

ART.6388

Extension N. 1
Videophone: 2

N.B.
Dopo ogni cambiamento nella programmazione del posto esterno, del videocitofono o del relè, è necessario togliere l'alimentazione al sistema e ripristinarla affinché le variazioni vengano recepite dai rispettivi dispositivi.

After each change on the programming of the door station, videophone or any other device connected to the system it is necessary to restart the system (power off then power on).

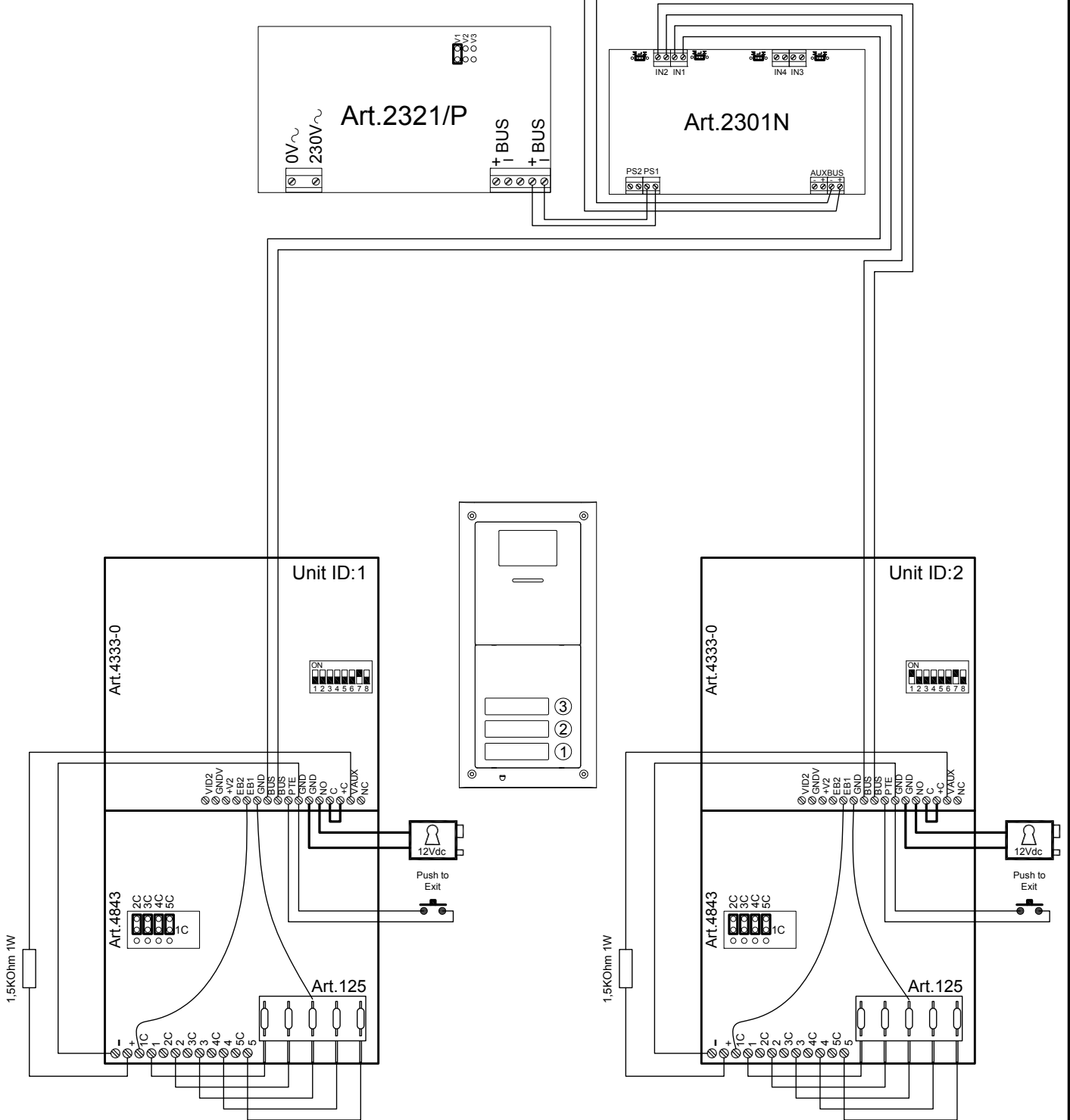

Title: 3 Apartments 2 Entrances Video Door Entry System

Data creazione: 11/12/2017 Foglio 1 / 1

Titolo:

Data modifica: 11/12/2017

Videx Electronics S.p.A.
Via del Lavoro 1, 63846 Monte Giberto (FM)
Phone: +39 0734 631669 - Fax +39 0734 631669
www.videx.it - info@videx.it

Notes:

.

Note:

.

Autore: Marco Rongoni

Cod. File: esvk-63h-007.dwg

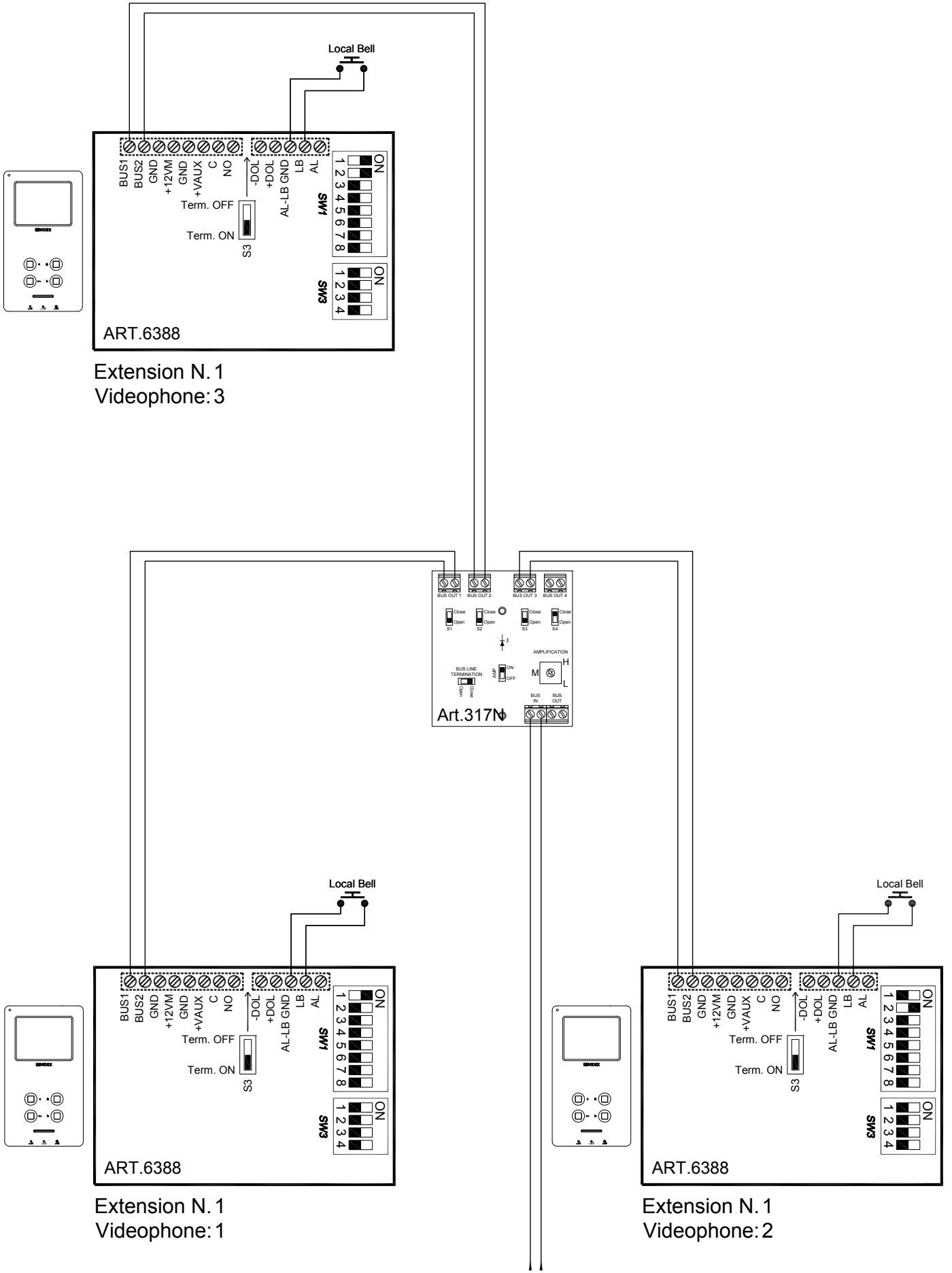

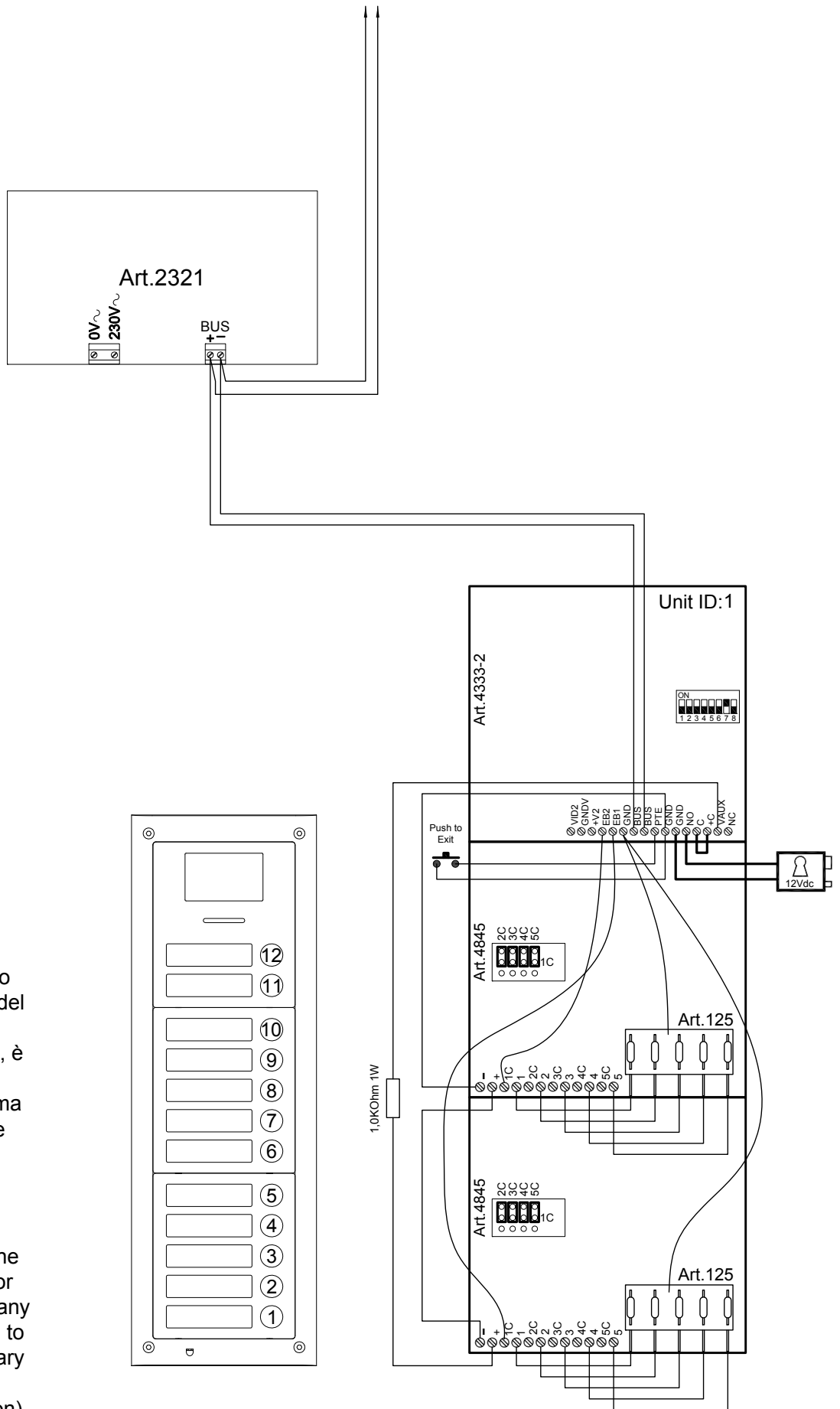

N.B.
 Dopo ogni cambiamento nella programmazione del posto esterno, del videocitofono o del relè, è necessario togliere l'alimentazione al sistema e ripristinarla affinché le variazioni vengano recepite dai rispettivi dispositivi.

After each change on the programming of the door station, videophone or any other device connected to the system it is necessary to restart the system (power off then power on).

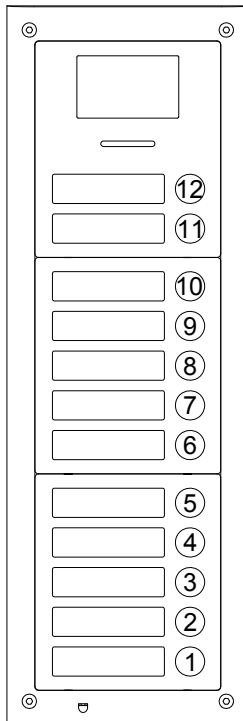

Title: **ESVK videokit expanded up to 12 apartments system**

Model: **Videokit ESKV con espansione fino a 12 appartamenti**

Videx Electronics S.p.A.
 Via del Lavoro 1, 63846 Monte Giberto (FM)
 Phone: +39 0734 631669 - Fax +39 0734 631669
 www.videx.it - info@videx.it

Notes:

Note:

Data creazione: **09/04/2018**

Data modifica: **20/06/2018**

Autore: **Roberto Gambini**

Cod. File: **esvk-63h-007a.dwg**

Foglio

1 / 4

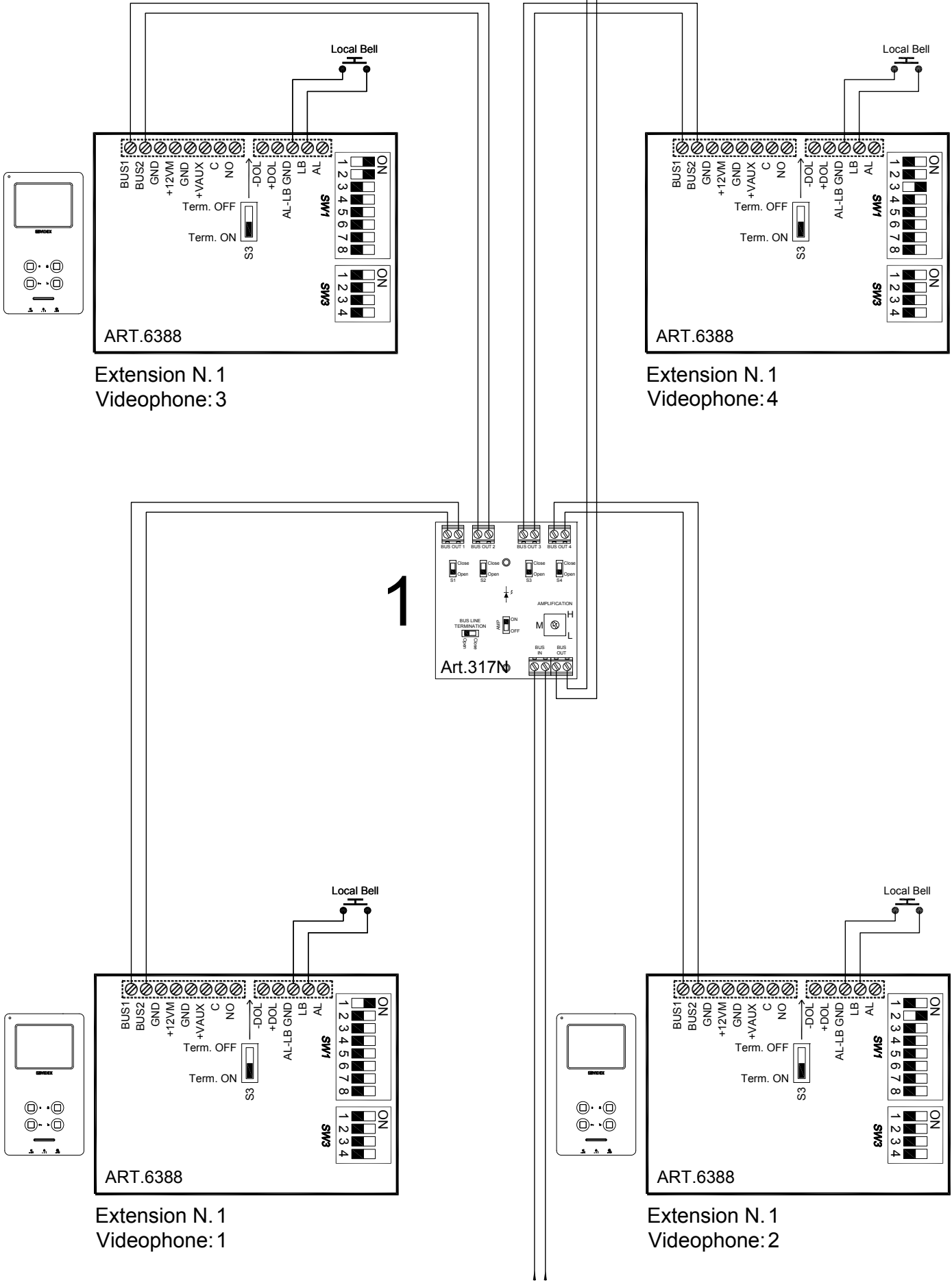

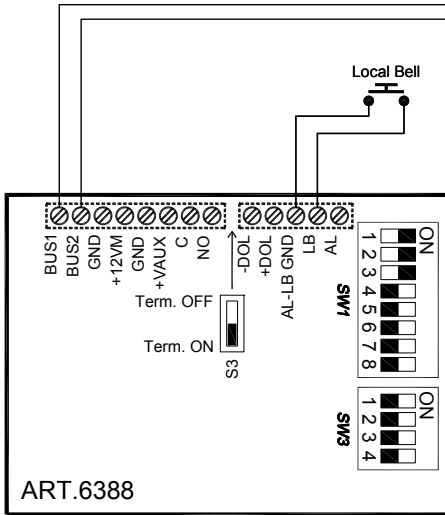
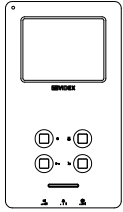

ART.6388

Extension N. 1
Videophone: 7

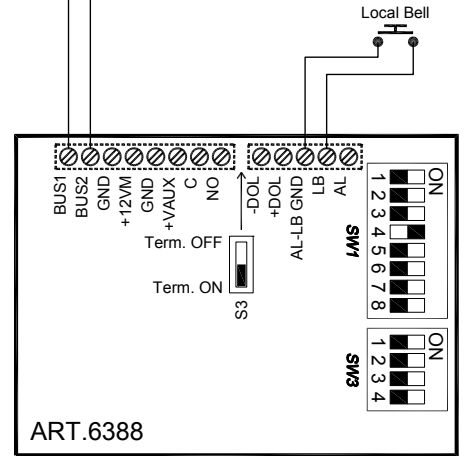

ART.6388

Extension N. 1
Videophone: 8

2

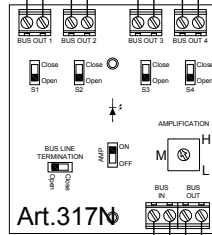

Art.317

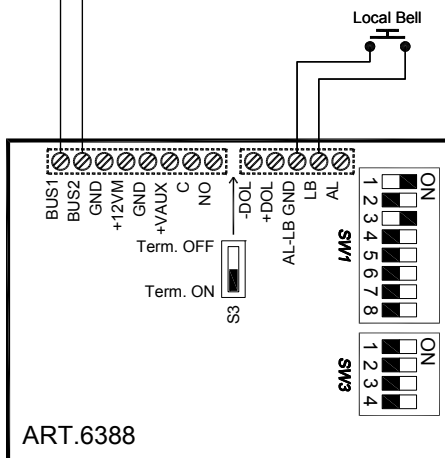
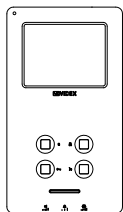

ART.6388

Extension N. 1
Videophone: 5

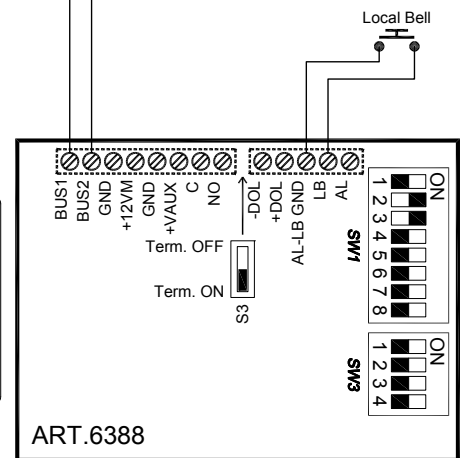
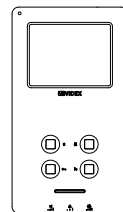

ART.6388

Extension N. 1
Videophone: 6

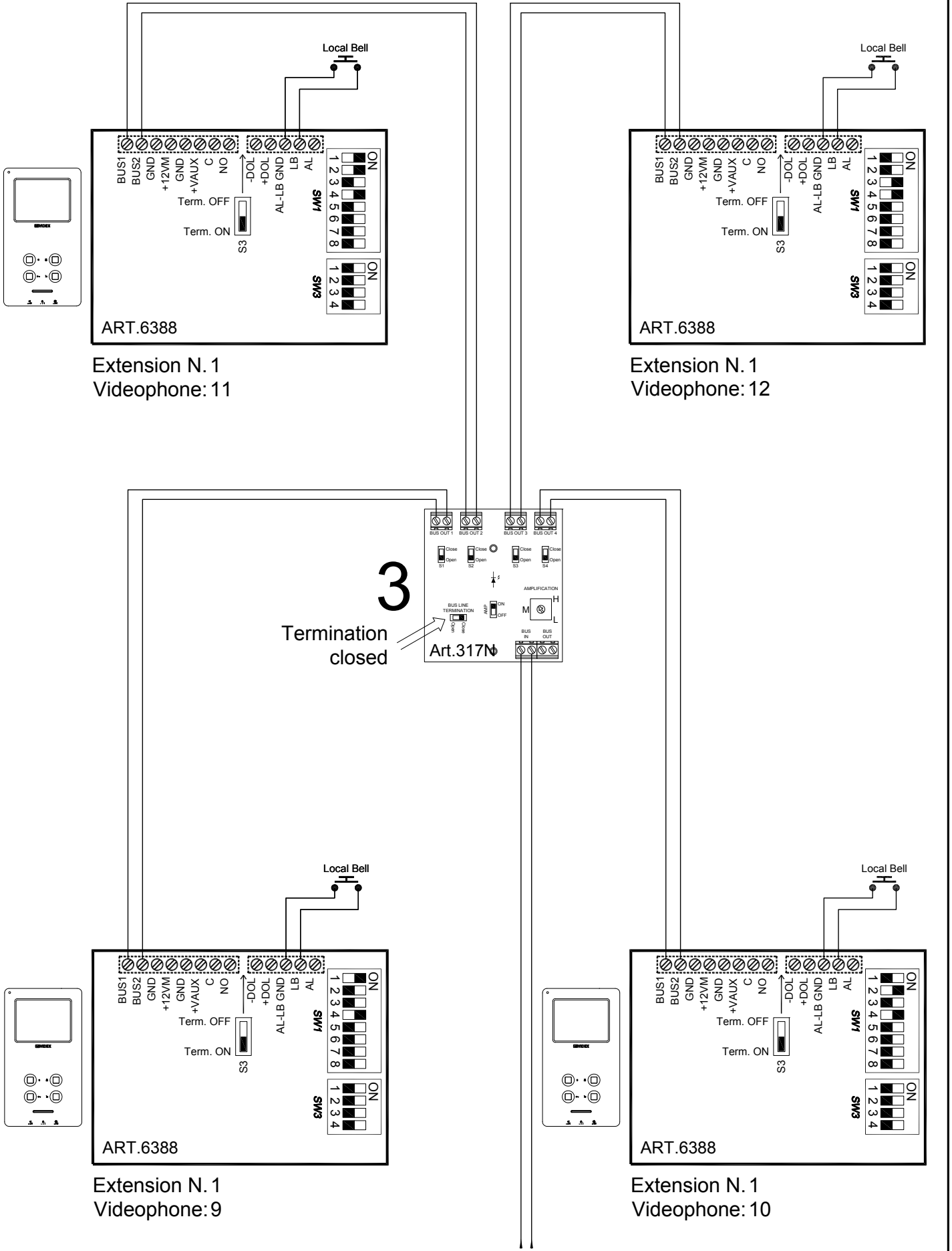

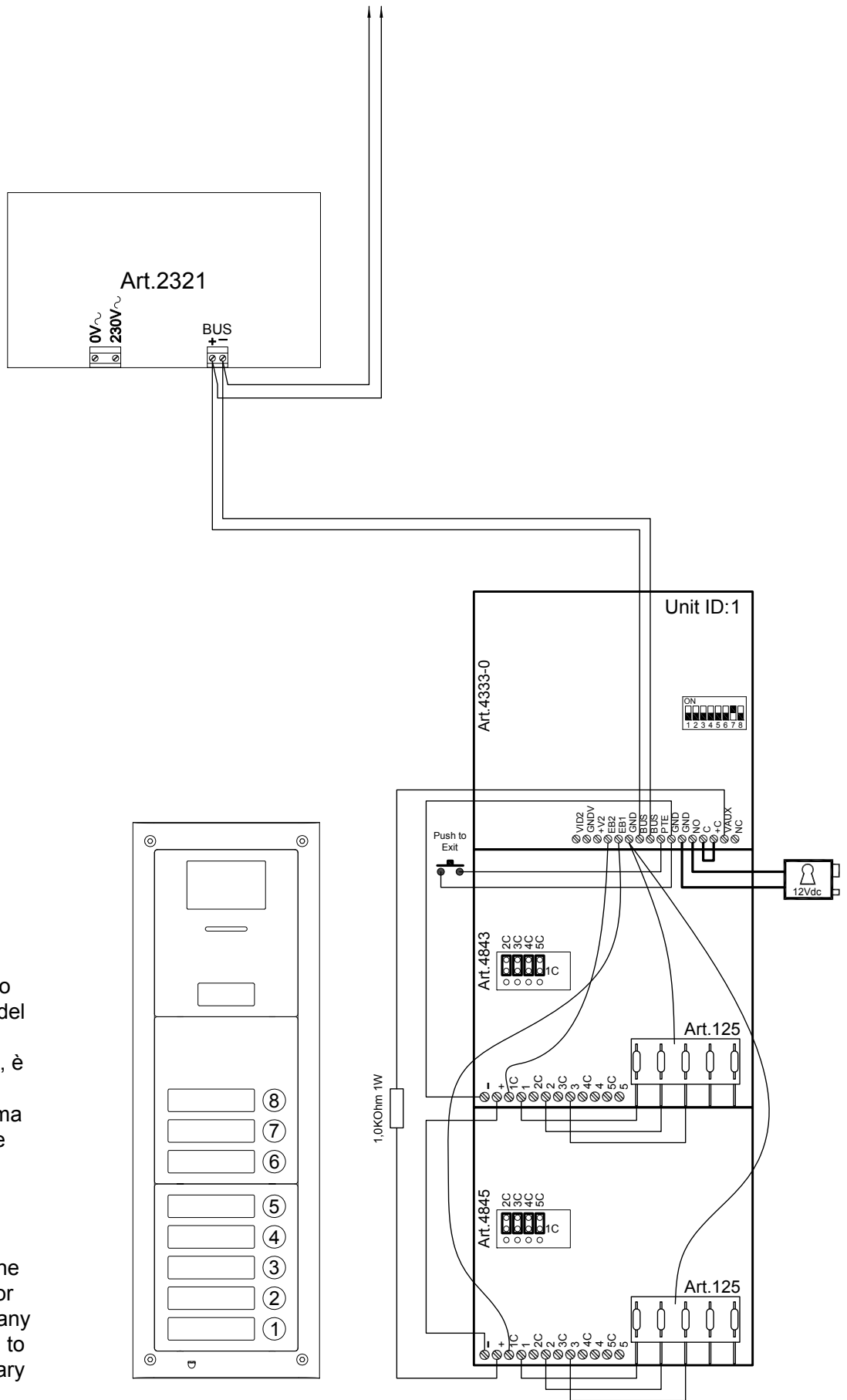

N.B.
 Dopo ogni cambiamento nella programmazione del posto esterno, del videocitofono o del relè, è necessario togliere l'alimentazione al sistema e ripristinarla affinché le variazioni vengano recepite dai rispettivi dispositivi.

After each change on the programming of the door station, videophone or any other device connected to the system it is necessary to restart the system (power off then power on).

Title: ESVK videokit expanded up to 8 apartments system		Data creazione: 09/04/2018		Foglio 1 / 3
Titolo: Videokit ESKV con espansione fino a 8 appartamenti		Data modifica: 13/04/2018		
Videx Electronics S.p.A. Via del Lavoro 1, 63946 Monte Giberto (FM) Phone: +39 0734 631669 - Fax +39 0734 631669 www.videx.it - info@videx.it		Notes: .	Autore: Roberto Gambini	
		Notes: .	Cod. File: esvk-63h-008.dwg	

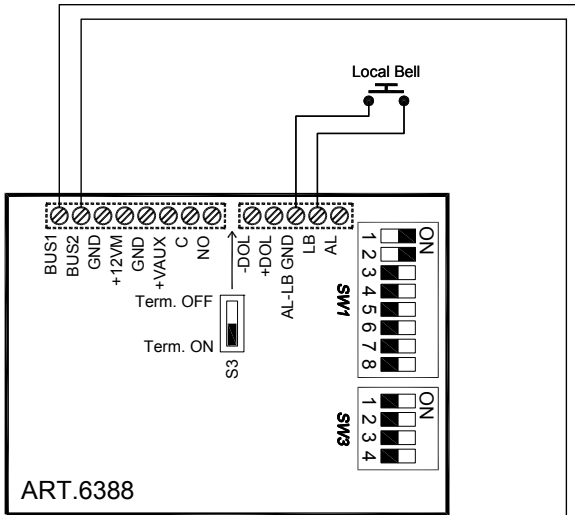
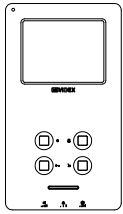

ART.6388
Extension N. 1
Videophone: 3

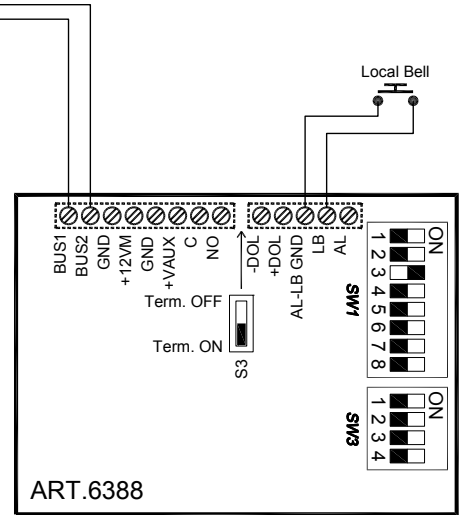

ART.6388
Extension N. 1
Videophone: 4

1

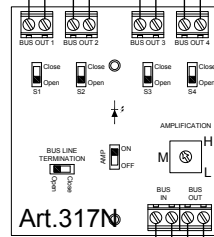

Art.317

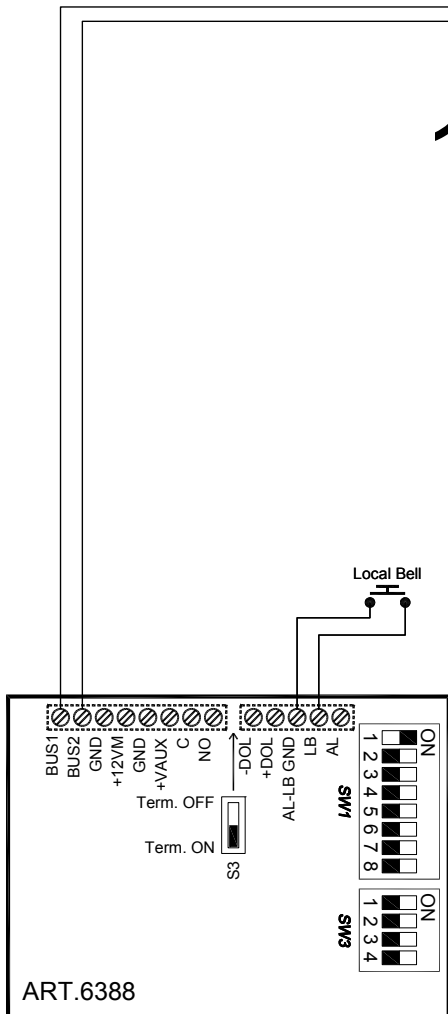
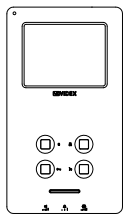

ART.6388
Extension N. 1
Videophone: 1

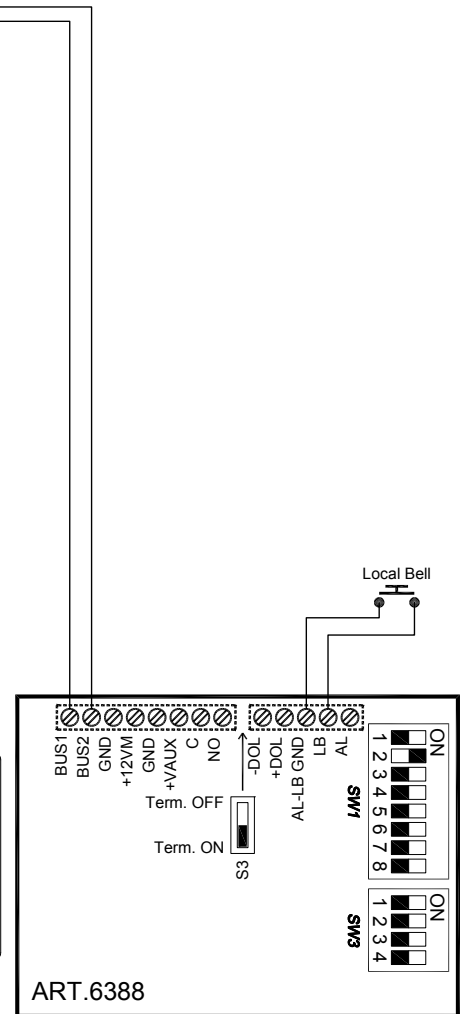
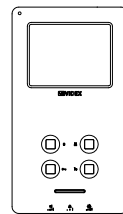

ART.6388
Extension N. 1
Videophone: 2

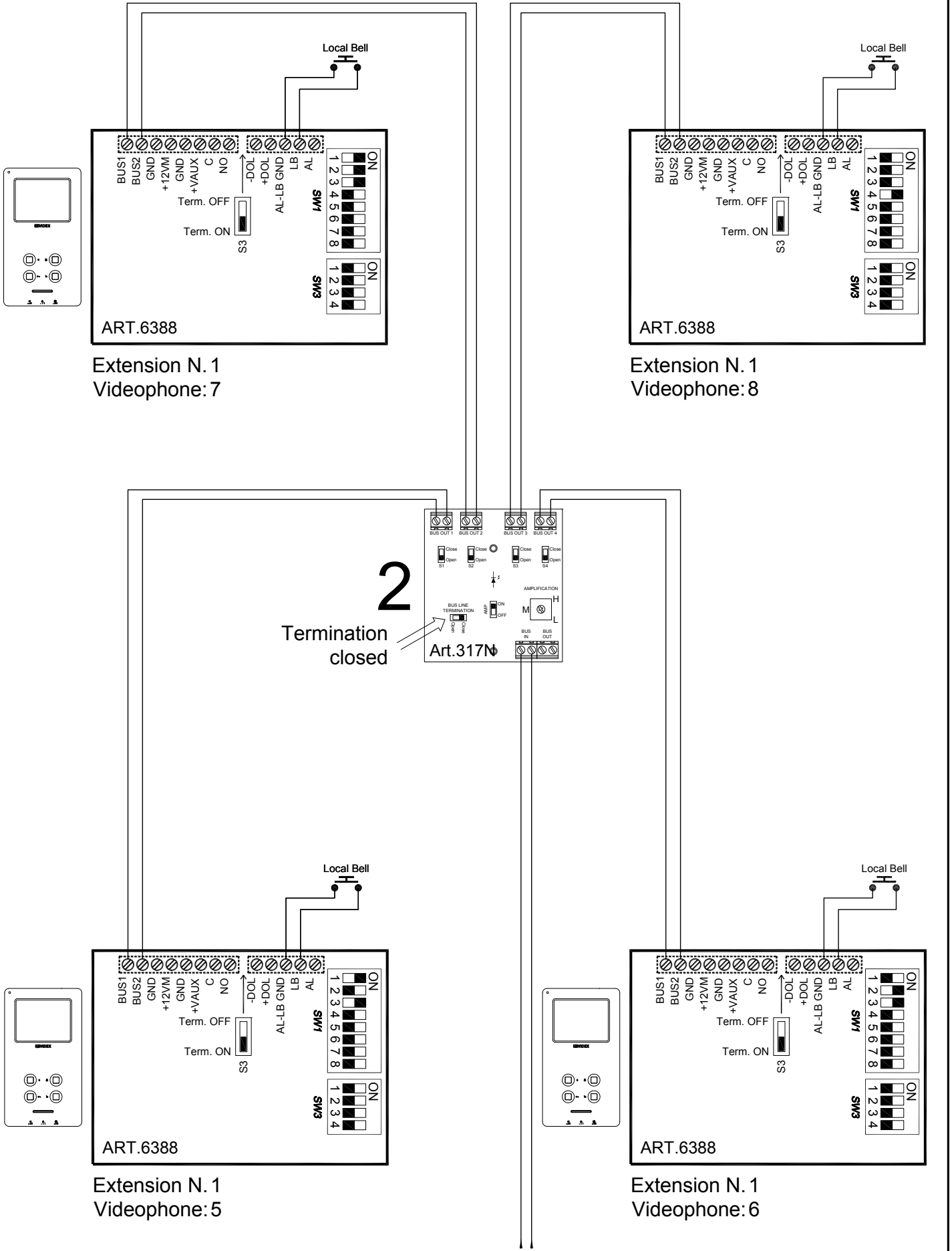

ENG DISPOSAL

In accordance with the Legislative Decree no. 49 of 14 March 2014 "Implementation of the Directive 2012/19/EU on waste electrical and electronic equipment (WEEE)".

The crossed-out bin symbol on the equipment or on the packaging indicates that when the product reaches the end of its lifetime, it must be collected separately from mixed municipal waste. The user must, therefore, dispose of the equipment at the end of its lifetime in the suitable waste collection centres or bring it to the retailer during the purchase of a new equipment of equivalent type at the ratio of one-to-one. Furthermore, the user is allowed to dispose of the WEEEs of very small size (domestic appliances without any external dimension exceeding 25 cm (9.84 inches) for free to the retailers, without any purchase obligation. The correct waste disposal of the WEEEs contributes to their reuse, recycling and recovery and avoids potential negative effects on the environment and human health due to the possible presence of dangerous substances within them.

ITA SMALTIMENTO

Ai sensi del Decreto Legislativo 14 marzo 2014, n° 49 "Attuazione della direttiva 2012/19/UE sui rifiuti di apparecchiature elettriche ed elettroniche (RAEE)".

Il simbolo del cassonetto barrato riportato sull'apparecchiatura o sulla sua confezione indica che il prodotto alla fine della propria vita utile deve essere raccolto separatamente dagli altri rifiuti urbani misti. L'utente dovrà, pertanto, conferire l'apparecchiatura giunta a fine vita presso gli idonei centri di raccolta differenziata oppure riconsegnarla al rivenditore al momento dell'acquisto di una nuova apparecchiatura di tipo equivalente, in ragione di uno a uno. L'utente ha, inoltre, la possibilità di conferire gratuitamente presso i distributori, senza alcun obbligo di acquisto, per i RAEE di piccolissime dimensioni (per le apparecchiature di tipo domestico con nessuna dimensione esterna superiore a 25 cm). L'adeguata raccolta differenziata dei RAEE contribuisce al loro riutilizzo, riciclaggio e recupero ed evita potenziali effetti negativi sull'ambiente e sulla salute umana dovuti alla eventuale presenza di sostanze pericolose al loro interno.

FRA ÉLIMINATION

Conformément au décret législatif n° 49 du 14 mars 2014 relatif à l'« Application de la directive 2012/19 / UE relative aux déchets d'équipements électriques et électroniques (DEEE) ».

Le symbole de la poubelle barrée sur l'équipement ou sur son emballage indique que le produit en fin de vie utile doit être collecté séparément des autres déchets municipaux en mélange. L'utilisateur doit donc remettre l'équipement en fin de vie aux centres de collecte appropriés ou le restituer au revendeur lors de l'achat d'un nouveau type d'équipement équivalent, dans le rapport de un à un. De plus, l'utilisateur a la possibilité de conférer gratuitement aux distributeurs, sans aucune obligation d'achat, de très petits DEEE (pour les appareils ménagers sans dimensions extérieures supérieures à 25 cm). La collecte séparée adéquate des DEEE contribue à leur réutilisation, leur recyclage et leur valorisation et évite les éventuels effets négatifs sur l'environnement et la santé humaine en raison de la présence possible de substances dangereuses dans ceux-ci.

SPA ELIMINACIÓN

De conformidad con el Decreto legislativo n. 49 de 14 de marzo 2014 "Aplicación de la Directiva 2012/19/UE relativa a residuos de aparatos eléctricos y electrónicos (RAEE)".

El símbolo del contenedor tachado indicado sobre los aparatos o sobre los embalajes señala que el producto al final de su vida útil debe ser recogido separadamente de otros residuos municipales mezclados. Por tanto, el usuario deberá conferir los aparatos al final de su vida útil en los apropiados centros de recogida selectiva o devolverlos al revendedor al momento de la compra de nuevos aparatos equivalentes, en una relación de uno a uno. Además, el usuario tiene la posibilidad de entregar sin cargo a los distribuidores, sin ninguna obligación de compra, los RAEEs muy pequeños (para electrodomésticos sin dimensiones externas superiores a 25 cm).

La recogida selectiva apropiada de los RAEEs contribuye a su reutilización, reciclaje y valorización y evita potenciales impactos negativos sobre el medio ambiente y la salud humana debidos a la posible presencia de sustancias peligrosas dentro de ellos.

NLD VERWIJDERING

In overeenstemming met het Wetsbesluit nr. 49 van 14 maart 2015 "Implementatie van de Richtlijn 2012/19/EU inzake afgedankte elektrische en elektronische apparaten (AEEA)".

Het doorgekruiste vuilnisbaksymbool op het apparaat of de verpakking geeft aan dat het product aan het einde van zijn levensduur niet samen met het gewone huisvuil weggegooid mag worden. De gebruiker moet het apparaat aan het einde van zijn levensduur inleveren bij een gepast inzamelpunt of de winkel waar hij een nieuw apparaat van een gelijksoortig type zal kopen. De gebruiker kan tevens AEEA's van een zeer klein formaat (huishoudapparaten met een buitenafmeting kleiner dan 25 cm (9,84 inch)) gratis en zonder enige aankoopverplichting bij handelaars inleveren. Een juiste verwijdering van AEEA's draagt bij tot hergebruik, recycling en terugwinning, en voorkomt potentiële negatieve effecten op het milieu en de menselijke gezondheid door de mogelijke aanwezigheid van gevaarlijke stoffen.

MANUFACTURER FABBRICANTE FABRICANT FABRICANTE FABRIKANT الشركة المصنعة	VIDEX ELECTRONICS S.P.A. Via del Lavoro, 1 63846 Monte Giberto (FM) Italy Tel (+39) 0734 631669 Fax (+39) 0734 632475 www.videx.it - info@videx.it	
CUSTOMER SUPPORT SUPPORTO CLIENTI SUPPORTS CLIENTS ATENCIÓN AL CLIENTE KLANTENDIENST خدمة العملاء	VIDEX ELECTRONICS S.P.A. www.videx.it - technical@videx.it Tel: +39 0734-631669 Fax: +39 0734-632475	UK Customers only: VIDEX SECURITY LTD www.videxuk.com Tech Line: 0191 224 3174 Fax: 0191 224 1559

*Main UK office:***VIDEX SECURITY LTD**

1 Osprey Trinity Park
Trinity Way
LONDON E4 8TD
Phone: (+44) 0870 300 1240
Fax: (+44) 020 8523 5825
www.videxuk.com
marketing@videxuk.com

*Northern UK office:***VIDEX SECURITY LTD**

Unit 4-7
Chillingham Industrial Estate
Chapman Street
NEWCASTLE UPON TYNE - NE6 2XX
Tech Line: (+44) 0191 224 3174
Phone: (+44) 0870 300 1240
Fax: (+44) 0191 224 1559

*Greece office:***VIDEX HELLAS Electronics**

48 Filolaou Str.
11633 ATHENS
Phone: (+30) 210 7521028
(+30) 210 7521998
Fax: (+30) 210 7560712
www.videx.gr
videx@videx.gr

*Danish office:***VIDEX DANMARK**

Hammershusgade 15
DK-2100 COPENHAGEN
Phone: (+45) 39 29 80 00
Fax: (+45) 39 27 77 75
www.videx.dk
videx@videx.dk

*Benelux office:***NESTOR COMPANY NV**

E3 laan, 93
B-9800 Deinze
Phone: (+32) 9 380 40 20
Fax: (+32) 9 380 40 25
www.videx.be
info@videx.be

*Dutch office:***NESTOR COMPANY BV**

Business Center Twente (BCT)
Grotestraat, 64
NL-7622 GM Borne
www.videxintercom.nl
info@videxintercom.nl



The product is CE marked demonstrating its conformity and is for distribution within all member states of the EU with no restrictions. This product follows the provisions of the European Directives 2014/30/EU (EMC); 2014/35/EU (LVD); 2011/65/EU (RoHS); CE marking 93/68/EEC.

Le produit est marqué CE à preuve de sa conformité et peut être distribué librement à l'intérieur des pays membres de l'union européenne EU. Ce produit est conforme aux directives européennes 2014/30/EU (EMC); 2014/35/EU (LVD); 2011/65/EU (RoHS); marquage CE 93/68/EEC.

Het product heeft de CE-markering om de conformiteit ervan aan te tonen en is bestemd voor distributie binnen de lidstaten van de EU zonder beperkingen. Dit product volgt de bepalingen van de Europese Richtlijnen 2014/30/EU (EMC); 2014/35/EU (LVD); 2011/65/EU (RoHS); CE-markering 93/68/EEC.

Il prodotto è marchiato CE a dimostrazione della sua conformità e può essere distribuito liberamente all'interno dei paesi membri dell'Unione Europea UE. Questo prodotto è conforme alle direttive Europee: 2014/30/UE (EMC); 2014/35/UE (LVD); 2011/65/UE (RoHS); marcatura CE 93/68/EEC.

El producto lleva la marca CE que demuestra su conformidad y puede ser distribuido en todos los estados miembros de la unión europea UE. Este producto cumple con las Directivas Europeas 2014/30/EU (EMC); 2014/35/EU (LVD); 2011/65/EU (RoHS); marca CE 93/68/EEC.

يحمل المنتج علامة التوافق الأوروبي CE لإظهار توافقه مع المواصفات ذات الصلة وإمكانية توزيعه في كافة دول الاتحاد الأوروبي بدون أية قيود. يلبّي هذا المنتج جميع متطلبات التوجيهات الأوروبية 2014/30/UE (EMC); 2014/35/UE (LVD); 2011/65/UE (RoHS) - (EMC); 2014/35/EU (LVD); 2011/65/EU (RoHS) - (EMC); 2014/35/EU (LVD); 2011/65/EU (RoHS); CE 93/68/EEC الأوروبية للمواصفات الأوروبية CE 93/68/EEC.

